

COBRA

427

CHASSIS INSTRUCTION BOOK
OWNERS HANDBOOK

Foreword

This book was written with the object of enabling the owner to maintain his car in perfect condition throughout its life.

The Cobra 427 Chassis is designed and built at the A.C. Factory, England, and like all other machinery of advanced design needs regular care and attention to give maximum results. A little time spent now and then in this direction will be amply repaid by ultimate performance.

Shelby America Inc. are responsible for the conception of the 427 chassis, and in America for the fitting of the engine, and gear box, manufactured by the Ford Motor Company of America.

A.C. Cars were happy to co-operate to produce a sports car of outstanding achievement.

SHELBY AMERICA INC.,
6501 WEST IMPERIAL HIGHWAY,
LOS ANGELES, CALIFORNIA 90009
Tel. 213 674-1961

A.C. CARS LTD.
Registered Office and Works:
THAMES DITTON, SURREY, ENGLAND

Telegrams:
"Autocarrier, Thames Ditton"

Telephone:
Emberbrook 5621

PRICE
40s.

A.T.G. Reprint #1 1990

USEFUL INFORMATION

DIMENSIONS

Wheel Base:	90"
Track:	Front: 53.96 Standard and Racing. Rear: 53 Standard—55.1/8 Racing.
Overall Length:	12' 10½"
Width:	5' 5½"
Height:	2' 11" Top of Scuttle—4' 1" Highest Point on Soft Top.
Weight:	2150 lbs.
Tyres:	8.15 x 15"
Petrol Tank Capacity:	15 Imp. galls, 18 U.S. galls.
Electrical Equipment:	12 volt.
Capacity of Engine Sump:	427 engine 6 U.S. quarts, 5 Imp. quarts. 289—6½ Imp. pints, including Filter— 7½ U.S. pints.
Capacity of rear Axle:	2½ Imp. pints, 3 U.S. pints, 1.4 litres.
Rear Axle Ratio:	3.54 or 3.31 to 1
Capacity of Gear Box:	2½ Imp. pints 289 / 3 Imp. pints 427.
Capacity of Radiator:	24 Imp. pints 289 / 28 Imp. pints approx. 427.
Chassis Number located on:	Front Left or Right Wishbone Flange.
Engine Number stamped on:	Engine Flange below rear L.H. spark plug and on Bulkhead plate.

IMPORTANT NOTE

Do not fit tyres of odd size to the rear wheels of the car. Running the car in this condition may cause damage to the differential.

The engine of the car must not be run with one rear wheel off the ground with the car in gear. Under these conditions the "Powr-Lok" differential will drive the car off the jack.

It is possible to drive the transmission by raising both wheels clear of the ground and running the engine with the car in gear.

The limited slip differential mainly when hot causes a certain amount of grabbing when the car is making slight or sharp turns at low speeds. This is a normal function with the "Powr-Lok" differential system.

COOLING SYSTEM

IMPORTANT

If the water level in the radiator header tank is to be checked while the engine is hot, the pressure in the cooling system must first be released by half turning the header tank filler cap. This permits pressure to be released through the overflow. It is dangerous to completely remove the filler cap when the engine is hot without releasing the pressure as described.

Cars with aluminium radiators are fitted with a water bleed valve to the cooling system. This must be removed in conjunction with the header tank filler cap when topping up with water. The system is full when water commences to flow from the bleed valve aperture.

It is advisable to run the engine a few minutes with the bleed valve and filler cap removed after topping up with water, this will ensure there are no air locks left in the system.

After running the engine, the water height should again be checked and added to if necessary. Where there is no bleed valve fitted the engine should be run with the header tank filler cap removed following the same procedure.

PROPELLER SHAFT AND HALF SHAFTS

These units are manufactured by Messrs. Hardy Spicer to exceedingly fine limits and are balanced to give freedom from vibration at all speeds. The needle type universal joints will give long and satisfactory service provided normal servicing is given, including greasing. Three such greasing points are provided on each wheel drive shaft, one on each spider and one on the slip splined joint. Two are provided on the propeller shaft spiders. Lubrication is best carried out when the car is raised from the ground and positioning of the shaft is necessary to allow the grease gun to be applied. Attention every 2,000—3,000 miles will suffice.

Messrs. Hardy Spicer provide replacement Universal Joint Sets, these consisting of a spider, four bearing races with needle rollers and snap rings.

In dismantling the Universal Joint observe the positions, this is so that the yokes may be assembled in their original balance order.

Remove the spring clips and push or drive the spider to one side, this will allow the race and needle bearing to come away. Reverse the procedure to remove the other bearing. The spider with one end of the yoke can then be removed. This procedure should be repeated to release the spider itself.

In assembly, apply grease to retain the needles in the races and observe that the sliding yoke is fitted to the correct splines. The yoke arms being in line with each other.

Propeller Shaft Unit Order Number D.66976

Half Shaft Unit Order Number 55-0107/KR

1350 YSA

SALISBURY DIFFERENTIAL UNIT 4HU

REMOVING THE COBRA DIFFERENTIAL ASSEMBLY COMPLETE

The differential casing is supported on three rubber mountings. Two of these are hanger bearings and are located on either side of the differential casing, the front bearing is mounted on the nose of the differential.

Unbolt the drive shaft flanges to the road wheels and the rear flange on the propeller shaft. Remove the front mounting bolts, and support the weight of the differential with a jack or block.

Remove the two side hanger mountings, it may be necessary to rotate the differential assembly when withdrawing the unit from the chassis.

DIFFERENTIAL MOUNTING

PART NUMBERS

FRONT SUPPORT CASTING	C-66091		(1)
Metalistic Mounting	13/1121	D-63784	(2)
Distance Piece	D-66202		(1)
Washer Internal Shake Proof $\frac{5}{8}$ "			(2)
$\frac{5}{8}$ " B.S.F. Bolts $2\frac{3}{4}$ " long (Hex.)			(2)
$\frac{7}{16}$ " U.N.C. Bolts $1\frac{1}{4}$ " long	D-66198		(4)
Support packing	D-66196		(4)
SIDE SUPPORT CASTINGS	D-66534		(2)
Metalistic Mounting	13/860	D-63503	(4)
	D-63503		
Support Bolt with Self Locking Nut			
$\frac{5}{8}$ " B.S.F. 7"	D-66208		(2)
$\frac{7}{16}$ " U.N.C. Bolts $1\frac{1}{2}$ " long	D-66199		(4)

THE SALISBURY "POWR-LOK" DIFFERENTIAL UNIT

WHY LIMITED SLIP DIFFERENTIALS ARE NEEDED

The purpose of a conventional differential is to provide equal torque division between the two road wheels whilst compensating for the difference in speed between the wheels when cornering. Since equal torque division is obtained at all times, the total torque transmitted is limited by the wheel with least adhesion. Whilst the limitation in performance of the conventional differential has been noticeable in the past when driving on ice or snow, these same factors are now assuming greater importance, due to the trend towards a lighter weight on the axle, combined with greater torque output from the engine. The Limited Slip Differential proportions the torque so that, at all times, the wheel with greater adhesion will transmit the greater portion of the torque available, whilst maintaining the necessary differential action on cornering.

POWR-LOK

The Powr-Lok design combines excellent performance with low initial cost and durability, and it is important to note that no other assembly combines these advantages to the same degree. In operation, the Powr-Lok combines the basic elements of the conventional differential with the restraint of friction clutches which provide the necessary torque bias. These basic features have been incorporated in a number of alternative designs but the Powr-Lok is unique in combining three alternative methods of loading which are supplementary and provide the necessary desirable qualities.

CONSTRUCTION

The cross pins which carry the pinion mates are so constructed that there is clearance at the intersection to permit relative movement between the two parts, each shaft having milled cam flats located in vee slots in the differential case halves. The pinion mates have shoulders engaging abutment faces on the clutch rings mounted adjacent to the differential side gears. The clutch rings and side gears have common splines locating on the axle shaft and the clutch rings are additionally provided with splined hubs carrying the alternative internally splined clutch plates. The remainder of the clutch plates are provided with 4 external lugs locating in slots in the differential case halves. All clutch plates are specially treated to obtain the desired friction characteristics and are flat with the exception of one plate for each assembly which is dished to provide a Belleville spring.

FRICITION CLUTCH LOADING

The loading of the friction clutches is effected by three different methods—

1. **Belleville Spring.** Since one of the plates in each clutch pack is dished to form a Belleville spring, the clutches are under a certain amount of pressure at all times and there is, therefore, effective restraint of free differential action, even if one wheel is clear of the ground. This point is of great importance, since the other means of loading are dependent on the degree of re-action at the axle shafts.

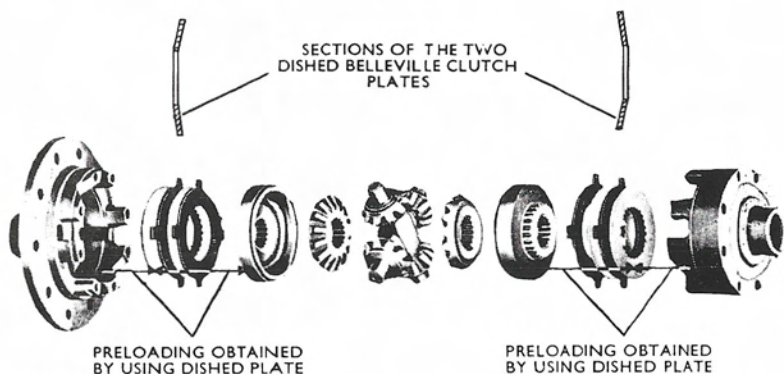

LOADING OF FRICTION CLUTCHES BY BELLEVILLE SPRING

2. **The Separating Forces of the Differential Gears.** As described, the differential side gear abuts against the side gear ring and the axial loading, due to the separating forces of the differential gears, is therefore transmitted to the clutch pack and this loading will be directly proportional to the torque transmitted by the gears.

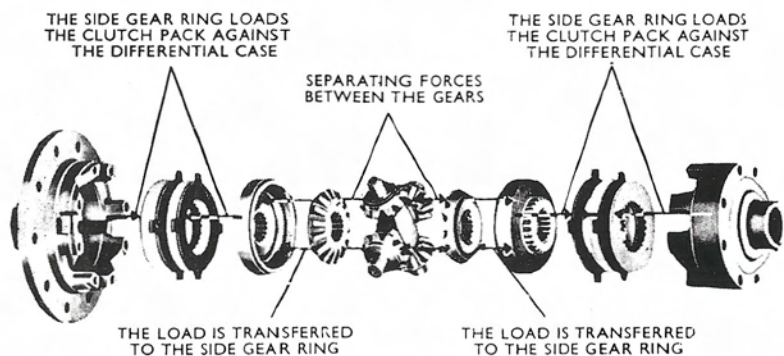

LOADING DUE TO SEPARATING FORCES OF DIFFERENTIAL GEARS

3. **Cam Loading.** The cam faces of the cross pins which engage vee slots in the differential case halves, impose a loading on the cross pins along the axis of the differential when torque is transmitted by the differential assembly. This re-action is transmitted to the side gear clutch rings through the abutment shoulders on the differential pinion mates.

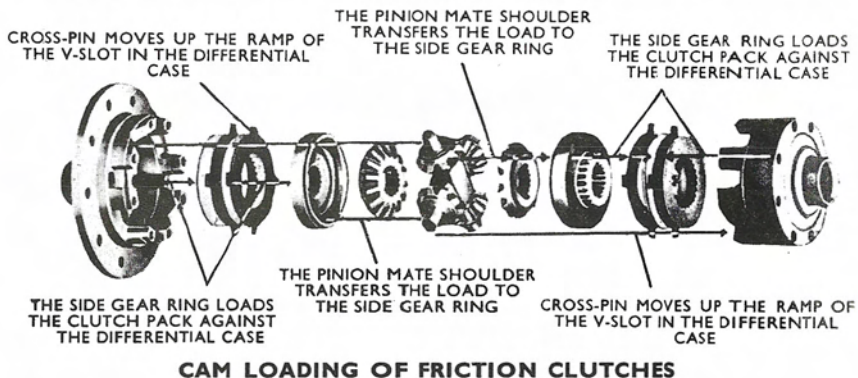

OPERATION

Under all normal driving conditions, the optimum balance between free differential action and frictional restraint of same is obtained due to the loading of the friction clutches by the combination of the differential gear separating forces and the cross pin cam loading. Since both these methods of loading are proportional to the torque transmission, there will be appropriate division of torque between the clutches and the differential gears. Under extreme conditions, however, when one wheel is on a surface giving extremely low or zero adhesion, it is necessary to provide additional torque bias, since the loading provided by the cam and gear forces depends upon there being a minimum degree of re-action at each axle shaft. In these circumstances, effective action is provided by the loading of the clutch packs by the Belleville springs.

It should be emphasized that the Powr-Lok design is unique, since the supplementary cam loading, in addition to the pressure on the clutch packs from the differential gears, makes it possible to use the minimum number of clutch plates, resulting in a compact assembly. It is also possible to utilize plates with comparatively low friction characteristics which can be maintained throughout the service life of the unit, hence the claim for durability.

POWR-LOK

Will prevent a vehicle from becoming immobile when one driving wheel loses traction.

Provides vehicle stability under adverse road conditions.

Controls wheel spin and resultant shock loads.

Reliable and effective throughout the service life of the vehicle.

SALISBURY DIFFERENTIAL DRAWING UNIT 4HU

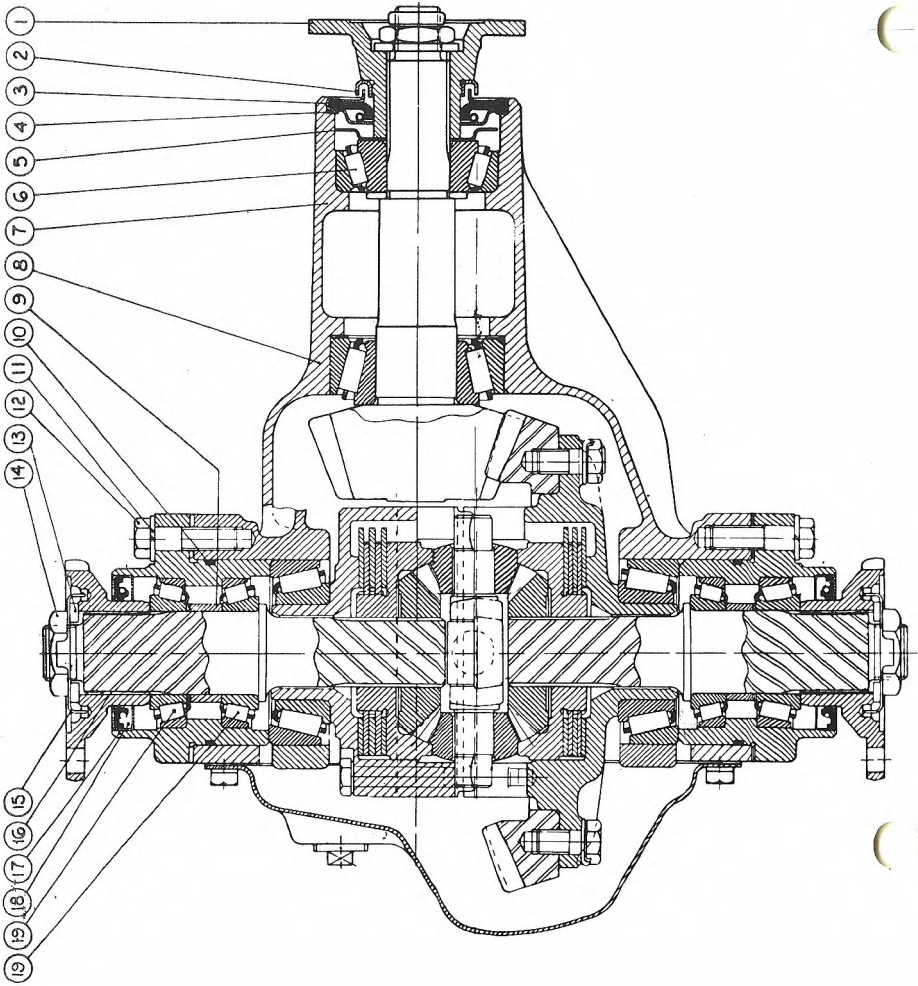

DIFFERENTIAL

PART NUMBERS

1.	Front Differential Flange	KA-2-1-GB11
2.	Oil Thrower	2HA-021
3.	Oil Seal	2HA-019
4.	Seating Washer	2HA-020
5.	Oil Thrower	4HA-036
6.	Timkin Taper Roller Bearing	2HA-022
7.	Differential Casing	4HU-004-12
8.	Timkin Taper Roller Bearing	2HA-023
9.	Distance Piece	4HU-018
10.	Sealing Ring	4HA-079-2
11.	Spring Washer	7LW-13
12.	Casing retaining bolt	7B-NC 44
13.	Metal Retaining Washer	16W-28
14.	Retaining Nut	4HU-089-1
15.	Flange Tab Washer	4HU-091-1
16.	Inner Drive Shaft	4HU-005-4
17.	Inner Drive Shaft Retaining Casing	4HU-014-1
18.	Oil Seal	4HA-079-1
19.	Timkin Taper Roller Bearing	4HU-025

REAR AXLE

Service tools recommended by Salisburys Ltd.

SERVICE TOOL LIST

Tool No.	Description
SE.101	Universal Dial Test Indicator, Catalogue No. 160, supplied by J. E. Baty & Co., Ltd., 39 Victoria Street, London, S.W.1.
SE.103	Pinion and Differential Bearing Cone Puller.
SE.105	Pinion Bearing Cup Extractor.
SE.106	Bearing Cup Installation Tool.
SE.107	Pinion Cone Setting Gauge.
SE.108	Pinion Oil Seal Installation Collar.

Complete sets of Service Tools are available from Messrs. V. L. Churchill & Co., Ltd., Great South West Road, Bedfont, Middlesex.

SERVICE DATA

	Model	6HA	HA	3HA	4HA	2HA	5HA
(a)	Pinion Drop "A" ...	1.000"	1.250"	1.375"	1.500"	1.750"	1.750"
	Zero Cone Setting "B" ...	2.000"	2.125"	2.250"	2.625"	2.750"	2.968"
	Mounting Distance "C" ...	3.375"	3.625"	3.937"	4.312"	4.625"	4.906"
	C/L to Brg. Housing "D" ...	4.193"	4.848"	5.130"	5.505"	5.818"	6.131"
		4.183"	4.838"	5.120"	5.495"	5.808"	6.121"
(b)	Axle Shaft End Float006" to .008" all Models					
	Torque Spanner Setting, Drive...	40-50	40-50	$\frac{3}{8}$ " 50-60	$\frac{3}{8}$ " 50-60	40-50	70-80
	Gear Bolts Lbs. Ft. ...			$\frac{7}{16}$ " 70-80	$\frac{7}{16}$ " 70-80		
	Diff. Preload Shim Allowance...	.005" all Models					
	Backlash ...	As etched on Drive Gear (Minimum .004")					
Pinion Bearing Preload ...	8-12 lbs. in all Models						

Service data concerning the 4HU differential is the same as the 4HA unit indicated above.

REFER TO PAGE 38 FOR RECOMMENDED OILS.

REMOVAL OF REAR HUB

TO REMOVE CALIPER—REAR BRAKES

1. Remove rear wheel.
2. Remove split pin and clevis pin from handbrake abutment. Fig. 18. (D.66053).
3. Remove wire on two caliper holding Bolts. Fig. 22.
4. Remove caliper holding bolts. Fig. 22 (D.66481).
5. The caliper must be suspended from the wishbone to prevent damage to the hydraulic brake pipe.
6. If the banjo bolt, Fig. 23 (376102W) is removed and the hydraulic pipe is disconnected, care must be taken that brake fluid is not permitted to drop on car paintwork.
7. It will be necessary to bleed the brakes if the hydraulic brake pipe is disconnected.

Note: Refer to rear hub drawing when carrying out this operation. Page 11.

TO DISMANTLE REAR HUB AND UPRIGHT

1. Remove caliper holding bolts Fig. 22 (D66481) and suspend caliper by wire from chassis tubing.
2. Disconnect parking brake cable from the abutment Fig. 18 (D66053) on upright.
3. Disconnect four holding bolts on drive shaft outer flange Fig. 15 (4HU-077-2).
4. Disconnect top wishbone upper ball joint, RBJ-76. Fig. 2, page 15.
5. Loosen the two $\frac{5}{16}$ " cramp bolts on the lower wishbone outer end and tap out holding pin, Fig. 6, page 15 (D.66851).

NOTE: Before undertaking the above operation, the disc and hub should be supported by wire from a chassis tube.

If the hydraulic brake pipes are disconnected from the caliper it will be necessary to bleed the brakes.

REAR HUB AND CALIPER DRAWINGS

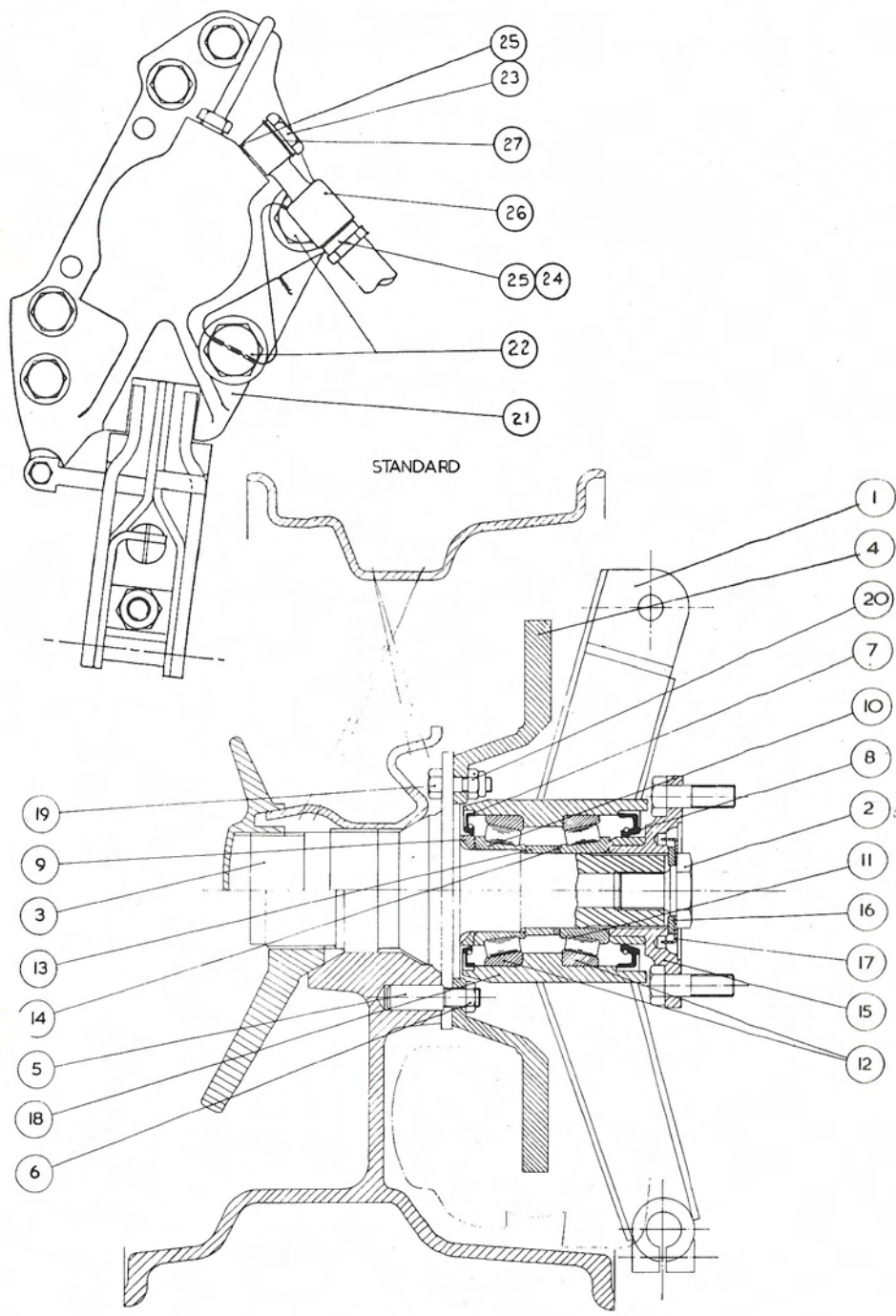

RACING

REAR HUB PART NUMBERS (STANDARD)

1. Rear Carrier	B-66912-3
2. Hub Flange Bolt	66074
3. Rear Hub	C-66858-9
4. Rear Disc	B.66908
5. Drive Pegs	Shelby American Inc.
6. Drive Peg Nuts	Shelby American Inc.
7. Oil Seal Outer "Burtonwood"	275-3346-10
8. Oil Seal Inner "Burtonwood"	187-318
9. Spacer	D-66871
10. Cone Outer "Timkin"	2774X
11. Cone Inner "Timkin"	2788A
12. Cup "Timkin"	2720
13. Distance Piece Large	D-66872
14. Distance Piece Small	67184
15. Flange "Salisbury"	4-HU-077-2
16. Washer "Salisbury"	16 W-28
17. Lock Washer	Salisbury 4-HU-091-1
18. Handbrake abutment	D-66053
19. Flange Bolt $\frac{5}{16}$ " B.S.F. High Tensile $1\frac{1}{8}$ "	
20. Flange Nut $\frac{5}{16}$ " B.S.F. Self-locking nut	
21. Caliper 12/3 Girling	64032764/5
22. Caliper Bolt	D-66481
23. Banjo Bolt Girling	376102W
24. Flexible Hydraulic Pipe	3700634W
25. Connecting Gasket	378711
26. Banjo	64474288
27. Banjo Gasket	378700

REAR HUB PART NUMBERS (RACING)

1. Rear Carrier	B-66914-5
2. Hub Flange Bolt	66074
3. Rear Hub	C-66860
4. Rear Disc	B-66909
5. Wheel Drive Pegs	Shelby American Inc.
6. Drive Peg Nuts	Shelby American Inc.
7. Oil Seal Outer "Burtonwood"	275-3346-10
8. Oil Seal Inner "Burtonwood"	187-318
9. Spacer	D-66871
10. Cone Outer "Timkin"	2774X
11. Cone Inner "Timkin"	2788A
12. Cup "Timkin"	2720
13. Distance Piece "Large"	D-66872
14. Distance Piece "Small"	67184
15. Flange "Salisbury"	4-HU-077-2
16. Washer "Salisbury"	16-W-28
17. Lock Washer	4-HU-091-1
18. Handbrake Abutment	D-66053
19. Flange Bolt $\frac{5}{16}$ " B.S.F. $1\frac{1}{8}$ " High Tensile	
20. Flange Nut $\frac{5}{16}$ " B.S.F. Self-locking	
21. Caliper ORA Girling	64032772/3
22. Caliper Bolt	D-66365
23. Banjo Bolt Girling	376102W

24. Flexible Hydraulic Pipe	2700634W
25. Connecting Gasket	378711
26. Banjo	64474288
27. Banjo Gasket	378700

TO REMOVE REAR WHEEL BEARINGS

1. Remove locking washer Fig. 17 (Salisbury 4-HU-091-1).
2. Undo and remove Hub Flange Bolt, Fig. 2 (66074).
3. Remove spacer washer, Fig. 16 (16W-28).
4. Remove drive flange, Fig. 15 (Salisbury 4-HU-077-2). This is a very tight fit and can only be removed with a press of a draw.
5. The hub carrier Fig. 1 (B-66912-3) will then lift away with the two oil seals Fig. 7 (Burtonwood 275-3346-10), Fig. 8 (Burtonwood 187-318), both bearing cups Fig. 12 (Timkin 2720) and the inner bearing cone Fig. 11 (Timkin 2788A).
6. The outer bearing cone Fig. 10 (Timkin 2774X) will remain on the inner hub shaft Fig. 3 (C-66858-9) with one large spacer Fig. 13 (D-66872), and one small distance piece Fig. 14 (67184), the spacers will lift away without difficulty but the outer bearing Fig. 10 (Timkin 2774X) then exposed will require a draw to facilitate removal.
7. The distance spacer Fig. 9 (D.66871) will lift away without trouble when the bearing is removed.
8. The bearing outer cups Fig. 12 (Timkin 2720) and oil seals Fig. 7 (Burtonwood 275-3346-10) and Fig. 8 (Burtonwood 187-318), which will have remained with the hub carrier Fig. 1 (B-66912-3) may be tapped out with a drift.

Note: There should be .1000 vertical float when the hub is assembled; the smaller distance piece mentioned above Fig. 14 (67184) measures between .150 to .170 according to the amount of hub float; care should be taken that the .1000 vertical float is maintained when the hub is reassembled.

Note: Part numbers quoted above are for a standard hub, racing part numbers are on page 12.

REFER TO REAR HUB DRAWING WHEN CARRYING OUT THIS OPERATION, PAGE 11

SUSPENSION UNITS

Upper Rear Wishbone Assembly (Photograph page 15)

Wishbone Welded Assembly C.66823 (Fig. 1 photograph)

Spherical Bearing Joint to Rear Vertical Link (Fig. 2 photograph)

Spherical Bearing Rod End RBJ-76 (Fig. 2)

Lock Nut $\frac{5}{8}$ " B.S.F. (Fig. 2)

Rubber Dust Shield R.R.58 (Fig. 2)

Spacer R.R.W.8 (Fig. 2)

$\frac{1}{2}$ " B.S.F. $2\frac{3}{4}$ " Bolt (Fig. 2)

$\frac{1}{2}$ " B.S.F. Self-locking nut (Fig. 2)

Upper Rear Wishbone Assembly Inner Bushes (Fig. 13 photograph)

Bush Metalastic 13/935 (Fig. 13)

Special Bolt D-67179 (Fig. 13)

$\frac{5}{8}$ " B.S.F. Self-locking Nut (Fig. 13)

Wishbone Pivot Cup D-66819 (Fig. 13)

Lower Rear Wishbone Assembly (Fig. 10 photograph)

Welded assembly Number B-66881-2

Inner Lower Wishbone Bearing (Fig. 11)

Adjusting Nut D-66829 (Fig. 11)

Sleeve D-66828 (Fig. 11)

O Ring (Superfect) S.H.96-307 (Fig. 11)

Spherical Bearing (Rose) RBJ-210 (Fig. 11)

Circlip (Anderton) NAM-1300 (Fig. 11)

Wishbone Pin and Bearings (Fig. 6 photograph)

Nylon bushes 12DU-16 (Fig. 6)

Rubber and metal seals 075-100-5BW (Fig. 6)

Clamp Bolts $\frac{5}{16}$ ", $1\frac{3}{4}$ ", $\frac{5}{16}$ " nut (Fig. 6)

Chrome Pin D-66851 (Fig. 6)

Rear Suspension Trailing Link (Fig. 8 photograph) 66877C

Trailing Link to Wishbone Bearing (Fig. 7)

Spherical Bearing and Circlip RBJ-205/Seeger Circlip $\frac{5}{16}$ " int. (Fig. 7)

3" Bolt (Fig. 7)

Two packing pieces (Fig. 7)

$\frac{1}{2}$ " Locking Nut (Fig. 7)

Trailing Link to Chassis Bearing (Fig. 9 photograph)

Spacer R.R.W.8 (Fig. 9)

Rubber Dust Seal R.R.S.8 (Fig. 9)

Spherical Bearing End Rod R.B.J.76 (Fig. 9)

$\frac{5}{8}$ " B.S.F. Lock Nut (Fig. 9)

5" Bolt X $\frac{1}{2}$ " (Fig. 9)

$\frac{1}{2}$ " Locking Nut (Fig. 9)

Two packing pieces (Fig. 9)

Rubber Bushes—Metalastic 13/1667, or Silentbloc E2088 (Fig. 9)

REAR SUSPENSION UNITS

1. Rear upper wishbone.
 2. Upper Wishbone to rear upright spherical ball joint.
 3. Rear brake caliper.
 4. Shock absorber bottom mounting, reference to page 36.
 5. Nylon bushes rubber and metal seals.
 6. Chrome pin.
 7. Trailing link, to lower wishbone, bearing.
 8. Trailing link.
 9. Trailing link to chassis bearing.
 10. Lower rear wishbone.
 11. Lower wishbone inner bearing.
 12. Differential front support, reference to page 4.
 13. Upper wishbone inner bushes.
 14. Differential side hanger bearings, refer to page 4.
 15. Shock absorber top mounting refer to page 36.
- Note:** Part numbers for suspension units above are itemised on page 14.
Shock absorber bearings page 36.

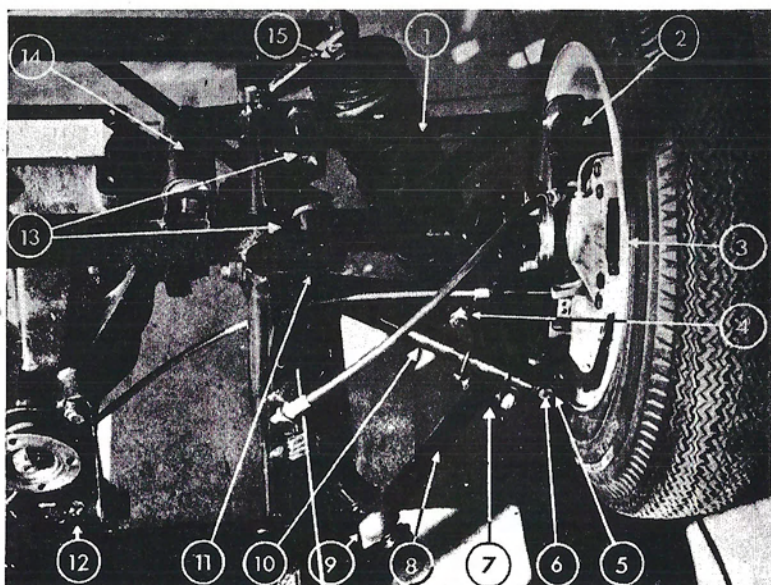

REAR SUSPENSION

Upper Unit

The rear suspension is comprised of an upper wishbone Fig. 1 (C-66823) which is suspended from the chassis by rubber bushes Fig. 13, page 15, (13/935) held in place by $\frac{5}{8}$ " bolts (D-67179) and cup washers $\frac{5}{8}$ " diameter (D-66819).

The bolts are inserted from inside the V of the wishbone with the cup washers inserted from outside, the assembly is retained by $\frac{5}{8}$ " locking nuts.

The outboard end of the upper wishbone comprises a $\frac{1}{2}$ " metal ball joint Fig. 2 (RBJ-76), and two packing washers, to which the rear upright is attached by a $\frac{1}{2}$ " \times $2\frac{3}{4}$ " bolt and $\frac{1}{2}$ " self locking nut, the ball joint is sealed and the rubber gaitered and requires no attention.

Above items detailed on page 14, under Upper Rear Wishbone Assembly.

REAR SUSPENSION

Lower Unit

The lower rear suspension unit comprises a narrow angle wishbone Fig. 10 (B-66881-2) page 15, with the triangle point chassis mounted, and a radius arm Fig. 8 (66877C), chassis located at the leading end Fig. 9, with the trailing end attached to the outer wishbone Fig. 7, page 15, this arm accepts braking and accelerating forces, all points of rear suspension are sealed on assembly, and do not require any further attention.

The inner wishbone bearing Fig. 11 comprises a sealed metal ball joint (RBJ-210), two circlips, a steel tube threaded at the ends, a $\frac{5}{8}$ " \times 4" bolt with locking nut. Attached to the threaded tube are two adjusting nuts, the positioning of which determines the running angle of the rear wheel.

The base of the rear upright is attached to the outer part of the wishbone by a chrome pin Fig. 6 (D-66851), which runs through nylon bushes Fig. 5 (12Du-16), inserted in the wishbone Fig. 10 (B-66881-2), the chrome pin is retained in position by clamp bolts $\frac{5}{16}$ ", $1\frac{3}{4}$ " and $\frac{5}{16}$ " nut at the base of the upright, each bearing is sealed against dirt and dust by rubber and metal seals.

This bearing does not require attention.

The trailing link Fig. 8 (66877C) is attached to the wishbone by a $\frac{1}{2}$ " ball joint Fig. 7 (RBJ-205), lubricated and sealed, a 3" bolt, two packing pieces and $\frac{1}{2}$ " locking nut. This bearing is grease packed and sealed and should not be touched.

The leading end of the radius arm is attached to the chassis by a $\frac{1}{2}$ " lubricated and sealed ball joint Fig. 9 (RBJ-76), operating in conjunction with two chassis mounted rubber bushes Fig. 9 (13/1667), a $\frac{1}{2}$ " \times 5" bolt, $\frac{1}{2}$ " locking nut and two packing pieces complete the assembly.

Above items detailed on page 14, under Lower Rear Wishbone Assembly and Rear Suspension Trailing Link.

REMOVAL OF FRONT HUB

Castor Angle	3°
Camber Angle front	Nil
Camber Angle rear	2° Neg.
Toe in front wheels	$\frac{1}{16}$ "
King Pin inclination	11°

TO REMOVE CALIPER FRONT BRAKES

1. Remove front road wheel.
2. Remove caliper bolt locking wire, Fig. 23.
3. Undo and remove the two 16/3P caliper holding bolts, Fig. 21 (D.66483)
4. The caliper, Fig. 22, must be suspended from the wishbone to prevent damage to the hydraulic brake pipe when the holding bolts are disconnected.
5. If the hydraulic brake pipe is disconnected Fig. 25 (64474288) care must be taken that brake fluid is not permitted to drop on the car body work.
6. It will be necessary to bleed the brakes as indicated on page 34, if the hydraulic brake pipe is disconnected.
7. When removing the caliper it will assist if reference is made to the front hub and caliper drawings, page 18.

TO REMOVE FRONT VERTICAL LINK

1. Unbolt caliper, Fig. 22 (16/3P), and suspend by wire from chassis tube.
2. Remove locking nut and wire from inside top wishbone, Fig. 1, page 23, and pull top of vertical link away. Fig. 2 (C.66813)—pages 18 and 23.
3. Remove with ring spanner, the locking nut visible at the base of the vertical link, and pull lower ball joint taper away, Fig. 3, page 23.
4. To remove the lower ball joint from the wishbone, remove the two wired cap holding bolts together with the cap, the ball joint will then withdraw through the base of the wishbone. Fig. 3, page 23.
5. The top ball joint may be removed from the upper wishbone tongue upon removal of the self locking nut. Fig. 2, page 23.

Reference should be made to the photographs illustrating the composition of the upper and lower ball joints, page 22, before undertaking verticle link removal.

The upper ball joint is a taper fit, and will require tapping to remove.

FRONT HUB AND CALIPER DRAWINGS

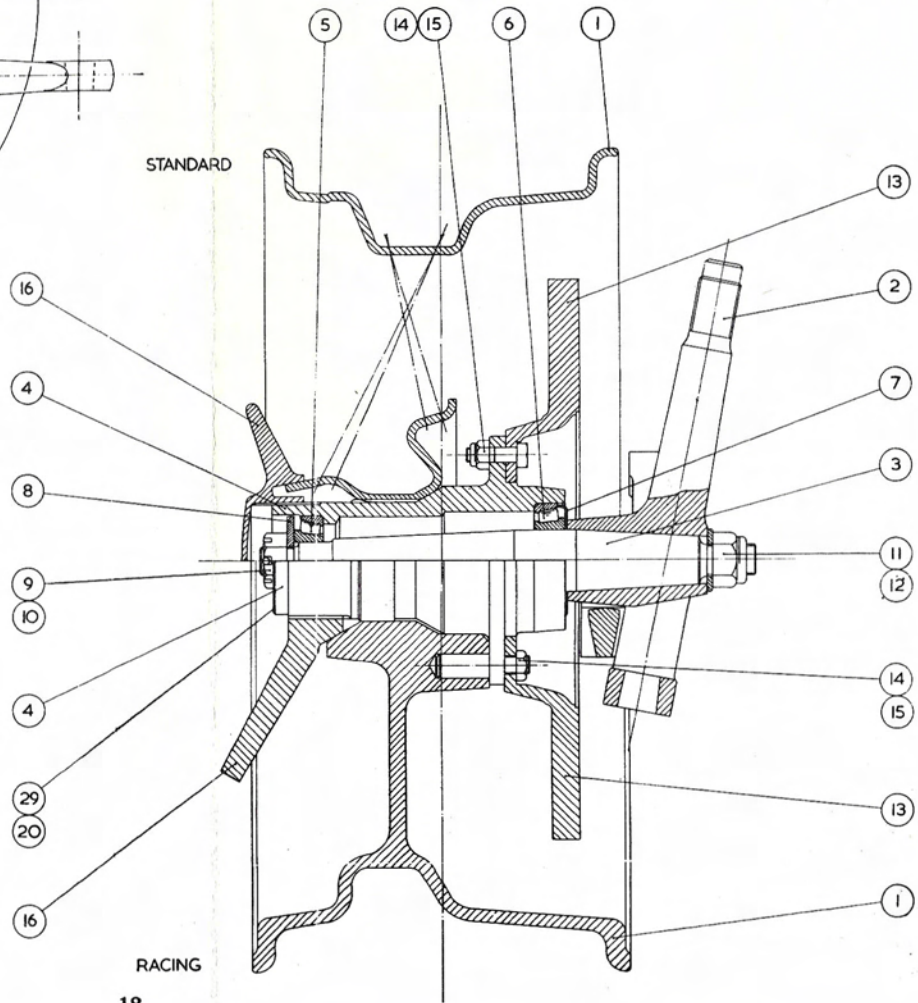
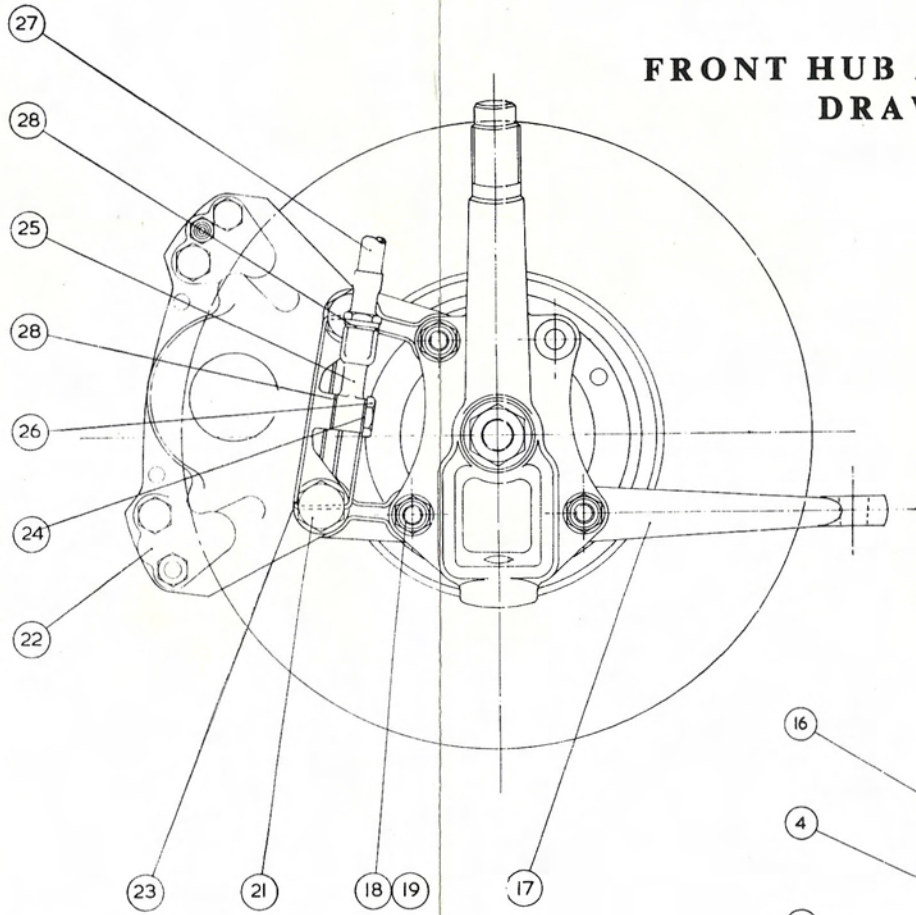

FRONT HUB PART NUMBERS (STANDARD)

1. Wheel Dunlop	
2. Vertical Link	C-66813
3. Stub Axle	D-66821
4. Hub	C-66852-3
5. Outer Bearing Cone/Outer Bearing Cup	LM.11949-LM.11910
6. Inner Bearing Cone/Inner Bearing Cup	LM.67048-LM.67010
7. Sealing Disc	D-66445
8. D-Washer	D-66446
9. $\frac{9}{16}$ " dia. B.S.F. Slotted Nut	FN.309
10. Cotter Pin $\frac{1}{8}$ " dia. $1\frac{1}{2}$ " LG	U.704
11. Washer $\frac{11}{16}$ " I.D. $1\frac{1}{2}$ " O.D. \times 8G	
12. $\frac{5}{8}$ " dia. B.S.F. Self locking nut	
13. Disc	B-66910
14. $\frac{5}{16}$ " dia. B.S.F. bolt \times $1\frac{1}{8}$ " HT	
15. $\frac{5}{16}$ " dia. B.S.F. Self-locking nut	
16. Hub nut	SK-686
17. Steering Arm	C-66460-1
18. $\frac{3}{8}$ " dia. B.S.F. Bolt 2" long	
19. $\frac{3}{8}$ " dia. B.S.F. self-locking nut	
20. O Ring	D-1614 M
21. Caliper bolt	D-66483
22. Caliper 16/3P	64032770-1
23. $\frac{1}{16}$ " dia. Soft locking wire	
24. Gasket	378700
25. Banjo	64474288
26. Bolt	376102W
27. Flexible hose Girling Long	3700634W
28. Gasket	378711
29. Hub Dust Plug	67197

FRONT HUB PART NUMBERS (RACING)

1. Wheel	Shelby American
2. Vertical Link	C-66813
3. Stub Axle	D-66821
4. Hub	C-66854-5
5. Outer Bearing Cone/Outer Bearing Cup	LM.11949-LM.11910 Timkin
6. Inner Bearing Cone/Inner Bearing Cup	LM.67048-LM.67010 Timkin
7. Sealing Disc Nilos	D-66445
8. D-washer	D-66446
9. $\frac{9}{16}$ " dia. B.S.F. Slotted Nut	FN.309
10. Cotter Pin $\frac{1}{8}$ " dia. $1\frac{1}{2}$ " long	U.704
11. Washer $\frac{11}{16}$ " I.D. $1\frac{1}{2}$ " O.D. \times 8G	
12. $\frac{5}{8}$ " dia. B.S.F. Self locking nut	
13. Disc	B-66911
14. $\frac{3}{8}$ " U.N.F. Peg nut	Shelby American
15. Wheel Peg	Shelby American
16. Hub nut	C-66849-50 Shelby American
17. Steering Arm	C-67023-4
18. $\frac{3}{8}$ " dia. B.S.F. Bolt 2" long	FB.106/16
19. $\frac{3}{8}$ " dia. B.S.F. Self locking nut	

20. O Ring	D-1614M
21. Caliper bolt	D-66476
22. Caliper	CR Girling
23. $\frac{1}{16}$ " dia. Soft locking wire	
24. Gasket	378700
25. Banjo	64474288
26. Bolt	376102W
27. Flexible hose, Girling, long	3700634W
28. Gasket	378711
29. Hub dust plug	67197

TO REMOVE FRONT WHEEL BEARINGS

1. Remove brake calipers and suspend by wire from chassis, do not disconnect hydraulic brake pipes unless bleeding of the brakes is desired. Do not allow hydraulic fluid onto paintwork. Detailed on page 17.
2. Prise out and remove aluminium dust cap, Fig. 29 (67197)—page 18.
3. Remove cotter pin from locking nut.
4. Undo and remove locking nut, Fig. 9 (FN.309).
5. Pull off hub, Fig. 4 (C.66852-3), with disc, Fig. 13 (B-66910), this will come away complete with a D washer, Fig. 8 (D-66446), and outer bearing complete, Fig. 5 (LM.11949-LM.11910).
6. The inner and outer roller, Fig. 5 and 6, cones will also come away with the hub.
7. The spindle is then exposed complete with inner bearing cup, Fig. 6, and oil retaining disc, Fig. 7 (D-66445).
8. Should it be desired to remove the hub stub axle, Fig. 3 (D-66821), from the front vertical link, Fig. 2 (C-66813), remove the locking nut, Fig. 12, and plain washer at rear of upright, the stub axle which is a taper fit, should then be loosened with a slight tap, care being taken not to damage the thread.

Part numbers quoted above are for a standard hub, Racing part numbers are quoted on pages 19 and 20.

FRONT SUSPENSION

Upper Ball Joint

The ball units attaching the top front wishbones to the front uprights are precision made bearings, which normally should operate for many thousands of miles without attention. Lubrication is by nylon impregnated hemispheres, which are sealed against dust, and dirt and do not require further periodical attention.

Should it ever become desirable to inspect this ball unit, the method of operation and construction becomes obvious on inspecting the exploded photograph on page 22.

1. Self-locking nut.
2. $\frac{1}{2}$ " plain washer.
3. Rubber dust cap.
4. Metal dust cap.
5. Upper casing.
6. Upper hemisphere. This is a nylon impregnated bearing with a light smear of graphite grease, on assembly.
7. Bearing pin.
8. Lower hemisphere, also nylon impregnated.
9. Spring tensioner. This is a spring washer, which should be assembled with the cone pointing upwards. The tensioner exerts a light pressure on the base of the lower hemisphere, ensuring continuous contact.
10. Flat distance washer.
11. Lower casing, which screws directly onto the top of the front upright. Three Allen screws, which have to be unscrewed before the lower casing may be removed.

Lower Ball Joint

The lower ball joint suspension unit is a sealed nylon impregnated hemisphere of similar pattern to the front suspension upper ball joint, and does not require maintenance. The method of construction and assembly is shown on the exploded photograph, page 22.

1. One $\frac{1}{2}$ " locking nut.
2. Recessed washer. This should be assembled with the recess facing downward.
3. Rubber dust cover.
4. Brass dust cover.
5. Steel dust cover.
6. Slotted nylon impregnated hemisphere bearing. This should be assembled with the slot at right angles to the main chassis tubes, lightly smeared with graphite grease on assembly.
7. Bearing pin.
8. Nylon impregnated lower hemisphere lightly smeared with graphite grease on assembly.
9. Spring tensioner which should be assembled with the cone pointing upwards, exerting light pressure on the lower hemisphere.
10. Lower casing cap.
11. Two spring washers.
12. Two Allen screws.

Note: The Allen screws are drilled and wired. Items 1-5 are assembled above the wishbone, items 6-12 are assembled below the wishbone.

PHOTOGRAPH UPPER BALL JOINT

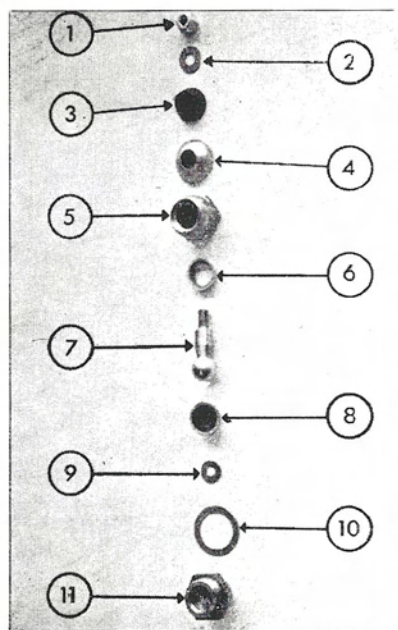

1. $\frac{1}{2}$ " B.S.F. Self-lock Nut.
2. $\frac{1}{2}$ " Plain Washer.
3. D-66368 Rubber Dust Shield.
4. D-66812 Dust Shield.
5. D-66811 Ball Cap.
6. D-66809 Upper Hemisphere.
7. D-66366 Ball Pin.
8. D-66370 Lower Hemisphere.
9. D-66407 Belleville Washer.
10. D-66810 Ball Cap Lock Washer.
11. D-66808 Ball Socket Casing.
Socket Screw Cap Point.

PHOTOGRAPH LOWER BALL JOINT

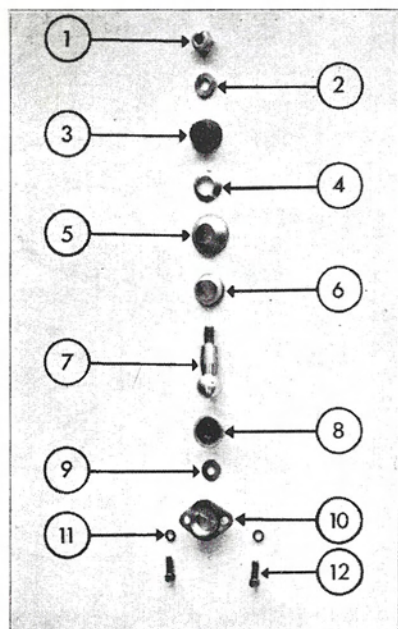

1. $\frac{1}{2}$ " B.S.F. Self-lock Nut.
2. D-66448 Special Washer.
3. D-66368 Rubber Dust Shield.
4. D-66803 Upper Dirt Shield Brass.
5. D-66802 Dust Shield.
6. D-66801 Upper Hemisphere.
7. D-66366 Ball Pin.
8. D-66370 Lower Hemisphere.
9. D-66407 Belleville Washer.
10. D-66329 Ball Cap.
11. $\frac{5}{16}$ " Spring Washer.
12. D-66447 Socket Head Screws.

FRONT UPPER AND LOWER WISHBONES

1. Front Wishbone C.66804.
2. Upper Ball joint.
3. Lower Ball joint.
4. Lower Wishbone B.66815-6.
5. Metalastic Bush 13-935, Bolt D-67179, $\frac{5}{8}$ " B.S.F. Self-locking Nut.
6. Wishbone Pivot Cup D.66819, Metalastic Bush 13-935, Bolt D-67179, $\frac{5}{8}$ " B.S.F. Self-locking Nut, Wishbone Pivot Cup D.66819.

FRONT SUSPENSION WISHBONES

The front upper and lower wishbones are attached to the chassis points by rubber bushes. The recessed washers are inserted from the outside top wishbone with the mounting bolts inserted from inside the wishbone.

The recessed washers are inserted from inside the lower wishbone with the mounting bolt pushed through from outside.

PHOTOGRAPH FRONT SUSPENSION

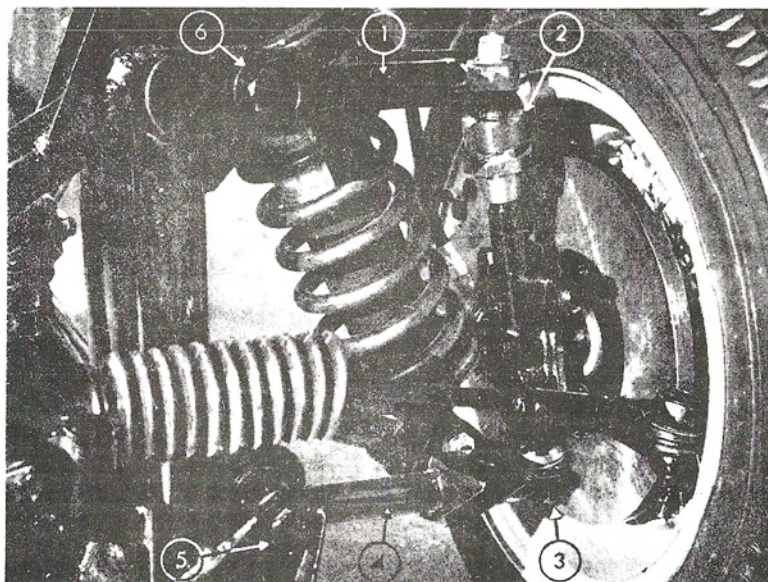

STEERING

LUBRICATION

The use of S.A.E.140 Hypoid oil is recommended for the steering rack, and only if this is not available may another heavy gear oil be substituted.

ADJUSTMENT

The steering damper is pre-set to provide the required amount of damping effect and should not be altered.

REMOVAL OF STEERING WHEEL

Remove the A.C. monogram from the steering wheel centre, undo and remove the exposed nut and washer. The steering boss aluminium casting is a tight fit and it may be necessary to make use of a draw to effect removal.

If the indicator and horn lever is to be removed, undo the grub screw located on the lever housing, disconnect the five electric wiring snap connections beneath the dashboard. The complete housing may then be removed from the steering column.

STEERING COLUMN REMOVAL

Remove the four pinch bolts at the top and base of the steering column lower section.

Slide the two universal joints together on the splines provided at both ends of column, it will then be possible to lift out the section complete.

To remove the top part of the column, undo the pinch bolts at the base of the shaft in the driving compartment.

Undo the slide bolt under the dashboard, the top column section may then be removed.

REMOVING STEERING RACK FROM CHASSIS

Jack up the front of car and remove road wheels. Loosen the pinch bolts on the steering column and pinion splines. Fig. 21 (steering drawing). Undo and remove the four $\frac{3}{8}$ " B.S.F. self-locking nuts from the steering rack assembly, undo the holding nuts on the steering arm ball joints.

The rack should be moved towards the radiator to provide clearance for the pinion shaft, and may then be removed through the wheel arch aperture.

When removing the steering rack from a right hand drive Cobra, the radiator should be drained and the bottom hose with the aluminium casting should be removed to obtain the necessary clearance.

It may be necessary to bend outwards the aluminium splash panel to provide sufficient clearance.

REFITTING THE STEERING RACK

The foregoing instructions will naturally be reversed when refitting the steering column.

STEERING ADJUSTMENT

The steering is mounted on a slide at the top end of the column, to raise or lower the steering undo the slide securing bolt, behind the dashboard, together with the bolt located at the lower end of the column in the driving compartment, the steering may then be adjusted to the desired position. Re-tighten bolts.

STEERING BALL JOINTS

These are prepacked and sealed and require no attention during service.

STEERING DRAWING

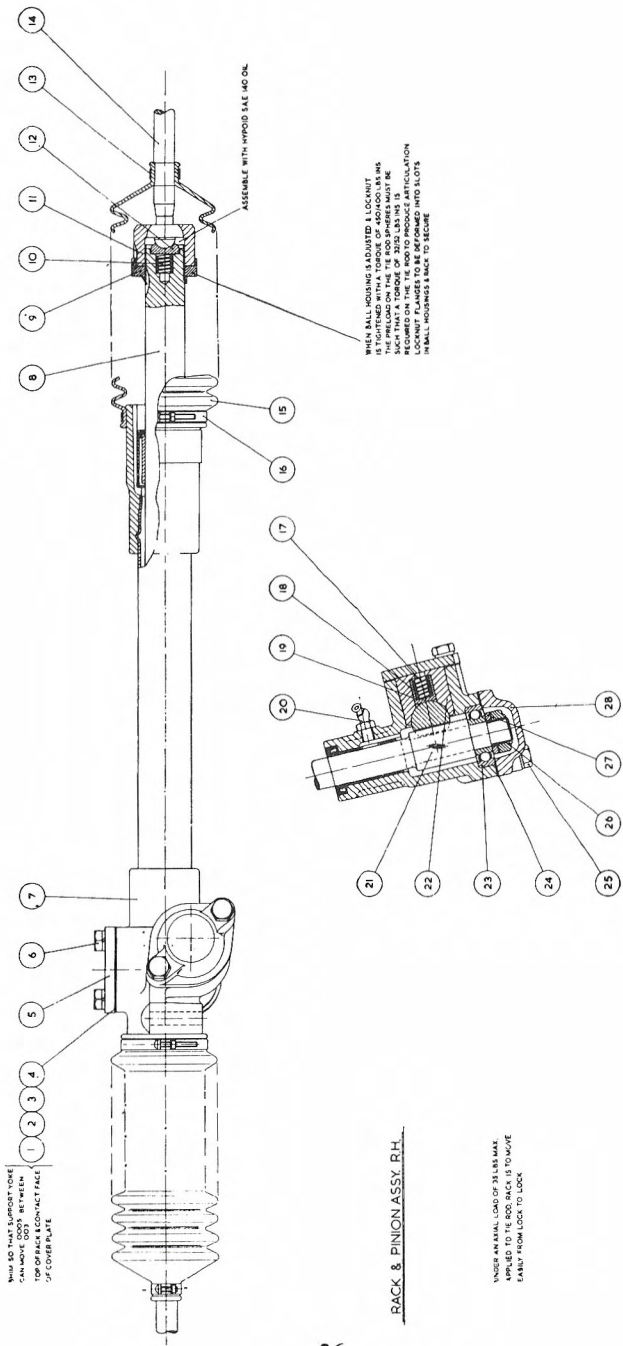

STEERING

PART NUMBERS

1.	18681	Shim, -0024"	As required
2.	18683	Shim, -010"	As required
3.	18682	Shim, -005"	As required
4.	19139	Joint	1
5.	19135	Cover Plate	1
6.	18271-S	$\frac{5}{16}$ " U.N.C. Bolt, $\frac{7}{8}$ " long	2
7.	70173	Rack Housing Assembly—Right-hand Drive	1
	70177	Rack Housing Assembly—Left-hand Drive	1
8.	19003	Rack for Left and Right-hand Drive Cars	1
9.	19008	Locknut	2
10.	18255	Thrust Spring	3
11.	19007	Ball Housing	2
12.	19004	Ball Seat	2
13.	16057	Seal Clip—Outer	2
14.	19006	Tie Rod	2
15.	18685	Rack Seal	2
16.	15258	Seal Clip—Inner	2
17.	18255	Thrust Spring	3
18.	13443	Damper Pad	1
19.	19498	Plain Washer	1
20.	19424	Grease Nipple—Right-hand Drive	1
	15771	Grease Nipple—Left-hand Drive	1
21.	19500	Pinion—Right-hand Drive	1
	19499	Pinion—Left-hand Drive	
22.	19136	Support Yoke	1
23.	18676	Ball Bearing	1
24.	18679	Joint	1
25.	18686-S	$\frac{5}{16}$ " U.N.C. Bolt \times $1\frac{1}{4}$ " long	2
26.	18677	Nut	1
27.	15481	$\frac{5}{8}$ " Spring Washer	1
28.	18678	End Cover	1

BRAKE INSTRUCTIONS

DESCRIPTION—THE GIRLING DISC BRAKE

Front Disc Diameter $11\frac{1}{8}$ ". Rear Disc Diameter $10\frac{1}{4}$ ".

The Girling Disc Brake is of simple construction consisting basically of a disc made from high quality cast iron and a cast iron caliper mounted on a support bracket.

The disc, which is attached to and rotates with the hub, is straddled by the caliper, held by two studs on the stub axle flange. On each side of the caliper the cylinders contain a rubber sealing ring positioned in a groove in the body and a piston protected by a dust cover. Inserted between the piston and the disc is the segmental lining pad bonded to a steel plate which is held in the body by retaining pins or plates.

Upon application of the brake pedal the hydraulic pressure generated in the system causes the co-axially aligned pistons to apply equal and opposite pressure by the friction pads on the rotating disc in direct proportion to the foot effort applied to the pedal.

When the pressure is released and the compression on the disc relieved, the pads and the pistons remain in a relaxed position with the pad just touching the disc ready for the next application. In this manner adjustment for lining wear is automatic and no manual adjustment is required.

The present disc brake has friction segments which operate on a small area of the braking surface leaving a large proportion of the disc exposed to the atmosphere, allowing maximum dissipation of heat.

Girling disc brakes fitted to the Cobra are self compensating and require no adjustment whatsoever. The hand brake from chassis CSX2188 is self adjusting and requires little attention.

RUNNING ADJUSTMENTS

CYLINDER MAINTENANCE

In order to replace the rubber rings or seals, it is necessary to remove the caliper assembly from the vehicle. The brake segments should be removed in the manner described and instead of pushing the pistons to the bottom of the bore withdraw them from the caliper body taking care not to damage the surfaces. The sealing rings may then be removed by inserting a blunt tool under the seals and prising out, taking care not to damage the locating grooves. Examine the bores and pistons carefully for any signs of abrasion or "scuffing".

It is important that in cleaning the components no petrol, paraffin, trichlorethylene or mineral fluid of any kind should be used. Clean with methylated spirits, allow to vaporize leaving the components clean and dry.

After cleaning and examining, lubricate the working surfaces of the bores and pistons with clean genuine Castrol Girling Brake and Clutch Fluid Crimson.

ASSEMBLING

Fit new rubber seals into the grooves of cylinder bore. Locate the rubber dust cover with the projecting lip in the groove provided, the outer one, in the cylinder bore.

Insert the piston, closed end first, into the bore taking great care not to damage the polished surface. Push the piston right home then engage the outer lip of the rubber boot in the groove.

The replacement of the lining pads as described on page 31 will retain the pistons in position.

Refit the caliper assembly to the support bracket by means of the two securing bolts confirming that the disc passes between the two pads. If packing shims are assembled between the caliper and the mounting face, it is important to replace them as initial assembly.

Re-connect the hose and bleed the brakes. Page 34.

LINING PAD REPLACEMENT

It is time to consider replacement when the lining pad is approximately $\frac{1}{8}$ " thick and under no circumstances should the pad be allowed to wear below $\frac{1}{16}$ " in thickness.

It is advisable to remove and reverse the positioning of the pads on front and rear brakes at 2,000 miles intervals. This procedure will not be necessary with the parking brake.

Note: Some Girling calipers are made in paired halves bolted together, it should be emphasized that no useful purpose can be served by separating the two halves of the caliper.

It should also be noted that some calipers are manufactured with an end plug on the side; these are tightened into the calipers by the manufacturers by special process and no attempt should be made to disturb them in the service.

CLUTCH BLEEDING

The Clutch hydraulic system may be bled in the same manner as the brake system explained on page 34, the bleed tube should be attached to the clutch slave cylinder and the clutch pedal depressed until all air is expelled from the system.

After bleeding the clutch the reservoir should be topped up with Castrol Girling brake and clutch fluid crimson.

The clutch reservoir should be examined and topped up during service periods, 2,000 mile intervals together with the two brake reservoirs, which are mounted on the bulkhead under the bonnet. The clutch reservoir is visible below the brake reservoirs.

GIRLING FRONT BRAKE CALIPER TYPE 16/3P

PART NUMBER 64032770/1

- 1. Front Brake Caliper
- 2. Brake Bleeder
- 3. Pad Retaining Shafts
- 4. Split Pin
- 5. Brake Pad

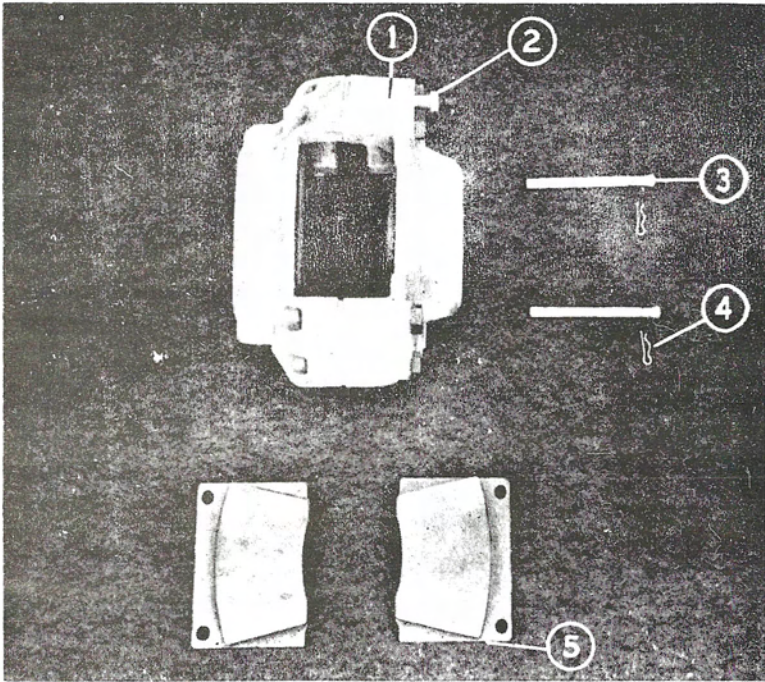

REMOVAL AND REPLACEMENT FRONT BRAKE PADS

1. Withdraw split pins on both pad retaining shafts.
2. Withdraw both pad retaining shafts. These are withdrawn and replaced from the inside of both calipers.
3. It will now be possible to withdraw both pads complete with metal backing plates.

REMOVAL AND REPLACEMENT REAR BRAKE PADS

1. Withdraw split pins on both pad retaining shafts.
2. Withdraw both retaining shafts.
3. It will now be possible to withdraw both brake pads complete with metal backing plates.

HAND BRAKE REPLACEMENT BRAKE PADS

1. Hold back spring tensioner and remove rubber dust cap from brake adjuster.
2. Remove split pin on pull rod pivot pin.
3. Tap out pivot pin.
4. Pull apart clamping levers and push down brake pull rod to permit easy withdrawal of brake pads.
5. The pads are both held by retaining springs which must be released before pads may be withdrawn.
6. It should now be possible to remove brake pads and backing plates from the socket provided without difficulty.

Note: When replacing rear brake pads the car must be jacked up and the road wheels removed.

When ordering new front or rear brake pads quote brake part number.

GIRLING REAR BRAKE CALIPER TYPE 12/3

PART NUMBER 64032764/5 EX

- | | |
|-----------------------------------|--------------------------|
| 1. Rear brake pad. | 7. Hand brake pads. |
| 2. Shaft retaining split pin. | 8. Split pin. |
| 3. Pad retaining shaft. | 9. Pull-rod pivot pin. |
| 4. Automatic hand brake adjuster. | 10. Hand brake pull-rod. |
| 5. Hand brake adjuster dust cap. | 11. Rear brake caliper. |
| 6. Hand brake pull-rod. | 12. Brake bleeder. |

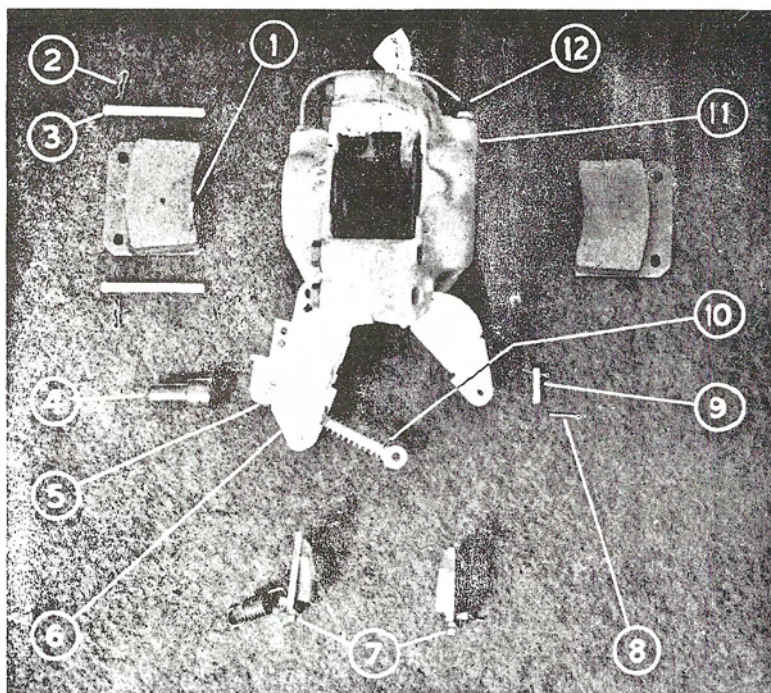

HANDBRAKE ADJUSTMENT

The handbrake pads are self-adjusting for wear. Should it become necessary to fit new pads as described on page 31, adjustment for clearance is automatically effected by applying the handbrake. It may be necessary to slacken off the adjuster slightly to allow for the increased thickness with the new pads. The handbrake cable is preset before the car leaves the works and should not require further adjustment when new pads are fitted.

BLEEDING THE SYSTEM

The process of bleeding is necessary only when a portion of the system has been disconnected, or when the level in the supply tank has been allowed to fall too low, thus permitting air to enter the fluid circuit. It consists of removing any air which may have found its way into the system. The GIRLING BRAKE FLUID used is specially prepared for the purpose and it is important that no other fluid be introduced into the system for replenishment or serious trouble will ensue.

PROCEDURE

The brake located the furthest distance from the Master Cylinder should be bled first so in the case of left-hand drive cars the following sequences should be adopted:

Rear Right-hand Wheel.
Rear Left-hand Wheel.
Front Right-hand Wheel.
Front Left-hand Wheel.

When bleeding the brakes on a R.H.D. car proceed as follows:

Rear Left-hand Wheel.
Rear Right-hand Wheel.
Front Left-hand Wheel.
Front Right-hand Wheel.

Bring all brake pads into contact with the discs by pumping the brake pedal a few times.

Fill up supply tank with fluid, exercising great care to prevent entry of dirt.

Take one brake at a time, jack up car and remove road wheel. Remove the rubber cover from the bleeder nipple of the brake cylinder, this will be found on the outside of the caliper. Fit rubber bleeder tube in its place, and allow to hang in a clean container or glass jar, always keeping end of tube below surface of fluid.

Unscrew the nipple about three-quarters of a turn with a suitable spanner, and operate brake pedal up and down a few times, lifting foot free from pedal after each application. One or two strokes will cause fluid to commence flowing, but pumping must be continued until the fluid appears entirely free from air. It is important that the reservoir is frequently replenished during this operation as should it be allowed to become empty, more air will be drawn into the system. After expelling all traces of air, tighten nipple with brake pedal depressed and repeat procedure with other wheels.

On completion make sure that reservoirs are topped up to correct level, i.e., three-quarters full. The dual reservoirs are located under the bonnet on the bulkhead just above the clutch reservoir.

Never use any fluid other than genuine Castrol Girling Brake and Clutch Fluid Crimson which can be obtained from any Girling Agent or direct from Messrs. Castrol Limited.

Always fit Girling factory replacement brake pads.

FRONT AND REAR SHOCK ABSORBERS

The Armstrong Hydraulic Heavy Duty Damper is fitted as a standard component to the suspension of the Cobra.

The damper is a double acting direct control unit which ensures a smooth damping of the spring oscillations on both bump and rebound.

The design and development of this unit is the result of close cooperation between A.C. Cars Ltd. and Messrs. Armstrong Ltd.

The damper is a self-contained and trouble-free unit and needs no servicing attention of any kind.

By means of a special seal in the damper the hydraulic fluid is kept in circulation in such a manner that leakage is not possible and therefore no "topping up" is required at any time.

The valving control built into these units is the result of extensive and exacting trials by Shelby America and A.C.

Should the dampers at any time require attention they cannot be repaired by a garage or service station but should be returned to the A.C. factory or Shelby American Inc. together with an order for replacement units.

SPRING AND DAMPER BEARINGS

The rear spring and damper bearings are sealed, and should not require any attention. The top mounting is by rubber bushes $\frac{1}{2}'' \times 3''$ bolts, self-locking nuts and $1\frac{1}{2}''$ plain washers. The lower damper bearing is a metal rose unit $\frac{5}{8}''$ dia. This is a metal swivel bearing rubber sealed and secured by a $\frac{5}{8}''$ bolt and self-locking nut. The metal distance piece is bonded to the rubber seal.

The front spring and damper bearings are the same as those fitted to the rear upper units being rubber bushed. The top unit is secured by a $3'' \times \frac{1}{2}''$ bolt with two $\frac{1}{2}''$ packing washers. The base is secured by a $2\frac{3}{4}'' \times \frac{1}{2}''$ bolt with two $\frac{1}{2}''$ packing washers.

Note: Reference should be made to pages 15 and 23, illustrating shock absorber location.

REAR SPRING UNIT

- A. Shock Absorber: C.66820 Armstrong; 4407 Racing; 4407/1 Standard.
- B. Coil Spring: C.66929 Racing and Standard.
- C. Spring Spacer: D.67124 Racing and Standard.
- D. Spherical Bearing Rose: RBJ-207. Racing and Standard
- E. Circlip: Anderton 2300/29 Racing and Standard.
- F. Bolt: $\frac{1}{2}''$ B.S.F., 3" long, Racing and Standard.
- G. Spacer: D.66919 Racing and Standard.
- H. Bolt: $\frac{5}{8}''$ B.S.F. 4 ins. long, Racing and Standard.
- I. Nut: $\frac{1}{2}''$ B.S.F. Self-locking, Racing and Standard.
- J. Nut: $\frac{5}{8}''$ B.S.F. Self-locking, thin, Racing and Standard.
- K. $\frac{1}{2}''$ Plain Washer, Racing and Standard.
- L. Metalastic Bush: Ultra Duty 13/12.39, Racing and Standard.

FRONT SPRING UNIT

- A. Shock Absorber: C.66817 Armstrong; 4405 Racing; 4405/1 Standard.
- B. Coil Spring: C.66931 Racing and Standard.
- C. Spring Spacer: D.67124 Racing and Standard.
- D. Bolt: $\frac{1}{2}''$ B.S.F., $2\frac{3}{4}''$ long, Racing and Standard.
- E. Bolt: $\frac{1}{2}''$ B.S.F., 3" long, Racing and Standard.
- F. Nut: $\frac{1}{2}''$ B.S.F. Self-locking, Racing and Standard.
- G. $\frac{1}{2}''$ Plain Washer.
- H. Metalastic Bush: Ultra Duty 13/12.39.

PETROL TANK REMOVAL

1. Jack up rear of car and remove road wheels.
2. Remove right-hand internal panel located in spare wheel well.
3. Undo lower petrol hose pipe clip visible through panel aperture.
4. Undo and remove the two tank supporting straps.
5. The petrol tank may now be removed from beneath the car.

RECOMMENDED OILS

ENGINE AND GEARBOX

Gearbox	Suitable Engine Oils
289—E.P.90 Oils	289—S.A.E.30 Castrol XL Energol S.A.E.30 Essolube 30, Shell S.A.E.30, Mobiloil A.
427—E.P.90 Oils	427—S.A.E.10-30 Grade Oils Castrolite or Simular or 30 Grade Oils as 289 engine.

STEERING RACK

The use of S.A.E.140 Hypoid oil is recommended for the steering rack, and only if this is not available may another heavy duty gear oil be substituted.

WHEEL HUBS

U.K.	Shell Retinax A.	Castrollease Heavy	Mobilgrease MP	Energrease L2	Esso High Temp. Grease
Overseas	Shell Retinax A.	Castrollease Heavy	Mobilgrease MP	Energrease L2	Esso Bearing Grease

CHASSIS GREASE POINTS

U.K.	Shell Retinax A.	Castrollease LM	Mobilgrease MP	Energrease L2	Esso Grease
Overseas	Shell Retinax A.	Castrollease LM	Mobilgrease MP	Energrease L2	Esso Chassis Grease

LUBRICATION

Correct and methodical lubrication is an essential point in obtaining perfect running from a car, a point where an occasional expenditure of time will be amply repaid by the results.

The mileages when the various points should receive attention are set out on page 39.

SALISBURY HYPOID REAR AXLE TECHNICAL DATA

Lubricants approved by Messrs. Salisburys for use in Salisbury Hypoid Rear Axles:

LUBRICANT

Hypoid Gear Oil S.A.E.90
 Esso Expee Compound 90
 Hypoid "Filtrate" Gear Oil S.A.E.90
 Silvertown Hypoid 90
 Mobilube GX.90
 "Oiline" H.A. Compound Hypoid Gear Lub. 90
 Energol E.P. S.A.E.90
 Ragsine Nimrod Hyp. (S.A.E.90)
 Redline Super Hypoid 90 Oil
 Caltex Hypoid Thuban 90
 Shell Spirax 90 E.P.
 Royal Snowdrift Gear Oil H.G. 90
 Vigzol Vitapoid 90
 Castrol Hypoy

ROUTINE MAINTENANCE

After first 500 miles	Monthly or every 1,500 miles	Twice yearly at seasonal change of oil or every 10,000 miles
Drain and refill oil	Check oil and top up if required	Drain and refill oil

OIL CAPACITY OF SALISBURY HYPOID AXLES

Model	Oil Capacity		
6 HA	1 $\frac{3}{4}$ pints	2 $\frac{1}{4}$ U.S. pints	1.0 litre
HA	2 pints	2 $\frac{1}{2}$ U.S. pints	1.1 litres
3 HA	2 $\frac{1}{4}$ pints	2 $\frac{3}{4}$ U.S. pints	1.3 litres
4 HA	3 pints	3 $\frac{1}{2}$ U.S. pints	1.7 litres
2 HA	3 pints	3 $\frac{1}{2}$ U.S. pints	1.7 litres
5 HA	3 pints	3 $\frac{1}{2}$ U.S. pints	1.7 litres

OIL CAPACITY 4HU DIFFERENTIAL UNIT FITTED TO COBRA

2 $\frac{1}{2}$ Imp. pints. 3 U.S. pints. 1.4 litres.

It is better always to use the same brand of oil and to avoid mixing, but in any case, use only one of the approved grades.

Oil drain plug located underside differential, lowest point.

Oil filler plug located at rear of differential, right side.

SERVICING, GREASING AND OILING INFORMATION

Every 200 miles

Examine oil level in sump and if necessary add oil to correct level.

First 500 miles

It is advisable after a new car has completed this mileage to drain the gearbox, rear axle and engine oils and refill with new oil. Drain from a plug at under side in all cases and fill to the levels indicated.

Change oil filter, and again at 2,500 miles with new engine. Change filter thereafter at 5,000 mile periods.

1,000 miles

Add distilled water to battery.

Check and top up if necessary brake master cylinder reservoirs with Castrol Girling Brake and Clutch fluid Crimson.

2,000 miles

Change engine oil.

Universal joints wheel drive shafts.

Splines on drive shafts.

Universal joints, propeller shaft.

3,000 miles

Oil Distributor very sparingly in aperture provided in Distributor Housing using S.A.E.30 Oil. Oil accelerator pedal shaft on bulkhead.

4,000 miles

Change Differential Oil.

Change Gearbox Oil.

Steering Pinion bearing, grease very sparingly.

5,000 miles

Grease nipples, parking brake cables.

Place S.A.E.30 oil sparingly on Carburettor linkages.

10,000 miles

Inspect front and rear hub bearings, grease should be applied only sparingly. Inject sparingly S.A.E.30 engine oil into lubrication hole on dynamo nose.

The steering rack is pre-packed and requires very little attention. Remove clip on rubber gaiter and insert S.A.E.140 Hypoid oil into gaiter end. Tighten gaiter clip.

Occasionally

Give the two pivots on the wiper arm a drop of oil; do not add more owing to the possibility of it getting on wiper blades.

Smear grease on battery terminals.

ELECTRICAL GENERAL MAINTENANCE

MAINTENANCE INSTRUCTIONS FOR LUCAS 12 VOLT ELECTRICAL EQUIPMENT AS FITTED TO A.C. COBRA

The electrical equipment is designed and manufactured to give long periods of service without any need for adjustment or cleaning.

Normally very little attention is required to the electrical equipment but for the benefit of those persons who desire, or find it necessary to carry out their own electrical maintenance, the electrical components of the Cobra are described in detail. It should be emphasized, however, that servicing of an advanced character may be carried out by the Lucas Service Organization, who have agencies in all parts of the world.

COIL

The coil requires no routine attention other than checking the terminal connections for security and cleaning the spaces around the terminals at intervals as necessary.

CONTACT BREAKER

During the first 500 miles (800 km.) running of a new car, the contact breaker heel tends to bed down; it is therefore advisable to check the gap at this stage. It is vitally important to keep the contact breaker points clean, set to the correct gap and parallel to each other.

SMITHS ELECTRIC ENGINE COOLING FAN

Type PES.2379/4 mounted ahead of radiator.

From car CSX.2080 fan mounting rear of radiator, Type PES.2626.

From chassis CSX.2167 inclusive, a Lucas electric cooling motor is fitted, Model 3GM with large cooling blades, located ahead of radiator.

The radiator cooling fan is fully automatic and is controlled by a thermostat switch located in the casting integral with the bottom radiator hose. No manual switch is provided.

427 Cobras are fitted with single or dual electric fans mounted behind the radiator. Type PES.2379/4, Smiths.

LUCAS 12 VOLT BATTERY TYPE FRT.9A

GENERAL INFORMATION — THE BATTERY

Occasionally check the condition of the battery by taking hydrometer readings of the specific gravity of the electrolyte in each of the cells. Readings should not be taken immediately after "topping-up" the cells. The specific gravity readings and their indications are as follows:

1.280 - 1.300. Battery fully charged.

About 1.210. Battery about half discharged.

Below 1.150. Battery fully discharged.

These figures are given assuming the temperature of the solution is about 60°F.

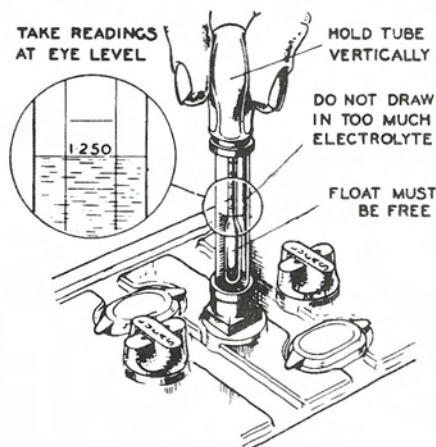

TAKING HYDROMETER READINGS

The readings for all cells should be approximately the same. If one cell gives a reading very different from the rest, it may be that acid has been spilled or has leaked from this particular cell or there may be a short circuit between the plates. In this case the battery should be examined by a Service Depot or Agent.

EVERY 1,000 MILES, OR MONTHLY

BATTERY. Remove the filler plugs from each of the cells of the battery and, if necessary, add sufficient distilled water to bring the electrolyte level with the tops of the separators, thereby replacing water which has been lost by evaporation. A Lucas Battery Filler will be found useful for topping-up. This ensures that the correct level is automatically obtained and also prevents distilled water from being spilled on top of the battery. Its use is particularly recommended on cars where visual examination of the electrolyte level is difficult. Do not use tap water. Never use a naked light when examining the conditions of the cells and never over-fill the cells when topping-up.

Wipe away any dirt or moisture from the top of the battery and make sure that the connections and fixing bolts are clean and tight.

Examine the terminals and, if necessary, scrape them clean and coat them with petroleum jelly. The taper fitting cable connector must never be hammered on to the terminal post nor should the self-tapping screw be used in an attempt to tighten the connector—if necessary, a light tap with the wooden handle of a screwdriver will do this, before the screw is fitted. The sole purpose of the screw is to maintain a tight joint after the connector has been fitted.

AMMETER READINGS

When noting ammeter readings, it must be remembered that during daytime running when the battery is in good condition, the dynamo gives only a trickle charge so that the charge reading will seldom be more than a few amperes.

A discharge reading may be given immediately after switching on the headlamps. This usually happens after a long time when the voltage of the battery is high. After a short time, the battery voltage will fall, and the regulator will respond, causing the dynamo output to balance the load.

When starting from cold, the charging current will rise until it reaches a steady maximum at a speed of say 20 m.p.h., after which it will remain fairly high for about 10 minutes and then fall to a steady charge which is most suitable for the particular state of charge of the battery.

It will be noticed from the ammeter readings that the dynamo does not charge at very low engine speeds. This is because it is not rotating fast enough to generate sufficient energy to charge the battery. The cut-out, which is an automatic switch connected between the dynamo and battery, allows the flow of current from the dynamo to the battery only. It closes when the dynamo is running fast enough to charge the battery and opens when the speed is low or the engine is stationary, thus preventing current flowing from the battery through the dynamo windings.

The regulator causes the dynamo to give an output which varies according to the load on the battery and its state of charge. When the battery is discharged, the dynamo gives a high output so that the battery receives a quick recharge which brings it back to its normal state in the minimum possible time.

On the other hand, if the battery is fully charged, the dynamo is arranged to give only a trickle charge which is sufficient to keep it in good condition without any possibility of causing damage to the battery by overcharging.

The regulator also causes the dynamo to give a controlled boosting charge at the beginning of a run which quickly restores to the battery the energy taken from it when starting. After about 30 minutes' running, the output of the dynamo falls to a steady rate, best suited to the particular state of charge of the battery.

LUCAS ELECTRIC HORNS

Model Numbers 69143A Low Note—69144A High Note.

All horns are adjusted during manufacture to give their best performance and will give a long period of service without any attention.

If one of the horns fails or becomes uncertain in its action it does not follow that the horn has broken down. First ascertain that the trouble is not due to some outside source, e.g., a discharged battery, or loose connection or short circuit in the wiring of the horn; a short circuit in the horn wiring will cause the fuse to blow. If both horns fail or become uncertain in action, the trouble is probably due to a blown fuse, defective relay or a discharged battery. If the fuse has blown, examine the wiring for the fault and replace the spare fuse provided. A defective relay must be replaced. A discharged battery can be recharged by a long period of day driving or from an external source of current.

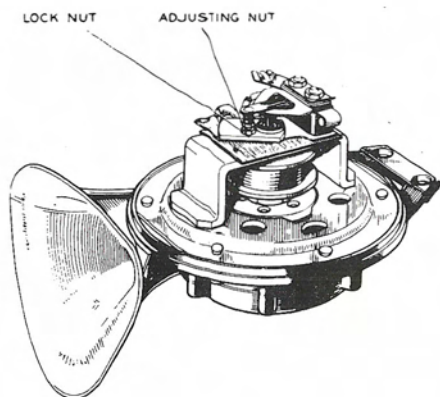

It is also possible that the performance of a horn may be upset by the fixing bolt working loose, or by some component near the horn being loose. If after carrying out the above examination the trouble is not rectified, the horn may need adjustment; but this should not be necessary until the horns have been in service for a long period.

Adjustment does not alter the pitch of the note, but merely takes up wear of moving parts. When adjusting the horns, short circuit the fuse, otherwise it is liable to blow. Again if the horns do not sound on adjustment, release the push instantly.

When making adjustments to a horn, always disconnect the supply lead to the other horn, taking care to ensure that it does not come into contact with any part of the chassis and so cause a short circuit.

ADJUSTMENT

Remove the horn cover after withdrawing the fixing screw and detach the cover securing bracket by springing it from its fixing.

Slacken the locknut on the fixed contact and rotate the adjusting screw until the contacts are just separated (indicated by horn failing to sound). Turn the adjustment nut half a turn in the opposite direction and secure in this position by tightening the lock nut. Finally if the note is still unsatisfactory, do not dismantle the horn but return it to a Lucas Service Depot or Service Agent for examination.

THE IGNITION SWITCH AND WARNING LIGHT

The ignition switch, besides forming a means of stopping the engine, is provided for the purpose of preventing the battery being discharged by the current flowing through the coil windings when the engine is stopped. A warning lamp is provided which gives a red light when the ignition is switched on and the car is running very slowly or is stationary, thus reminding the driver to switch off.

Should the warning lamp burn out, this will not in any way affect the ignition system, but it should be replaced as soon as possible in order to safeguard the battery.

DASHBOARD BULBS

Ignition Warning Lights

2½ volt - 3 watts.

High Beam Warning Light

12 volt - 2.2 watt.

Direction Indicators Warning Lights

12 volt 2.2 watt Phillips.

Speedometer and Revolution Counter

12 volt 2.2 watt Phillips.

Electric Clock

Phillips 12 volt 2 watt 12829.

Panel Light Bulbs (Two)

12 volt 3 watt MCC P53 B 643 Torpedo Type Bulb.

BULB AND HEADLAMP INFORMATION

Lucas Sealed beam headlights 12 volt 60-45 watt (American continent) model number SZA20.

Lucas LeMans Yellow Bulbs. Phillips Duplo 371 imp. 12 volt 45/40 watt (France and Europe). Despatch Number 51534.

Lucas LeMans White Bulbs. Phillips Duplo 12741 12 volt 45/40 watt. Despatch Number 51534.

Standard Lucas headlamp, Right Hand Drive White Bulb (England) Aisk Osram 12 volt 50/40 W 414 Despatch Number 58260.

Marchal Asymmetrical Headlamps Standard Optique.

Marchal Bulbs 1263B clear glass. 1263 J Cadmium Yellow Glass.

Lamp Model Number. Standard 6063.

Model Number DeLuxe 6963 (England and Europe).

SIDE AND TAIL LAMPS

SIDE/FLASHER LAMPS

To gain access to the bulb, turn the rim anti-clockwise, which will release the glass and rim from the lamp. Note the bulb has offset securing pins and can only be inserted in the holder the correct way round, thus ensuring the low wattage filament is used for the side lamp and high wattage for the flasher.

American cars are fitted with Amber glass in front flasher indicator.

TAIL/FLASHER LAMPS

Access to the bulbs is obtained from the inside of the boot. As in the side lamp bulb the securing pins are offset.

REAR LIGHTS INDICATORS AND STOPLIGHT

Phillips HO 380 12 Volt 6/21 watt -44 Offset pins.

SIDELIGHTS, FRONT AND INDICATORS

Phillips No. 380 12 volt 6/21 watt -44 Offset pins.

LUCAS TWO SPEED WINDSCREEN WIPER

MODEL 073152 (DR3)

The windscreen wiper consists of a powerful electric motor which transmits motion to the wiper arm spindle through a flexible cable rack mechanism. All moving parts are packed with grease during assembly, and no adjustment is required.

The motor incorporates an overload protective device in the form of a thermostat which under conditions of excessive heating will disconnect the current supply to the motor. When the motor windings have cooled and normal conditions restored, the wiper will automatically re-start.

A switch is situated in the centre of the instrument board. To bring wipers into operation turn the switch to the right. The wiper is so wired as to be inoperative when the ignition is turned off.

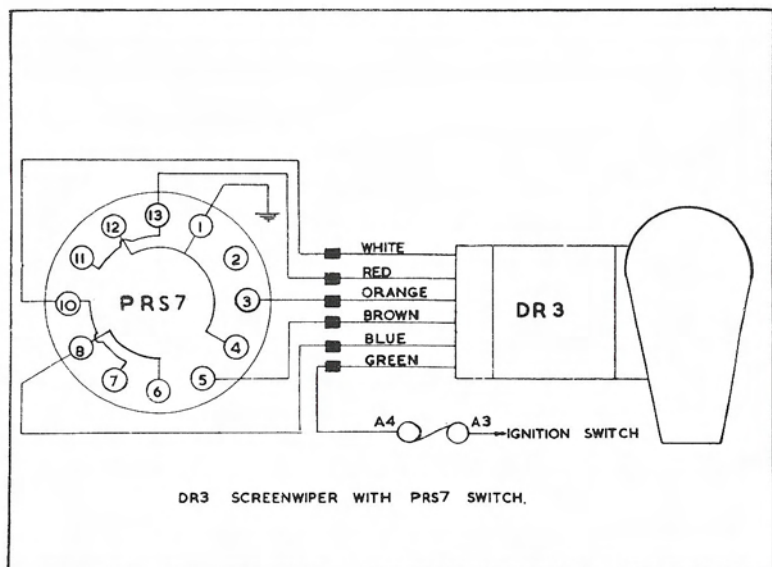

LUCAS WINDSCREEN WIPER DR3

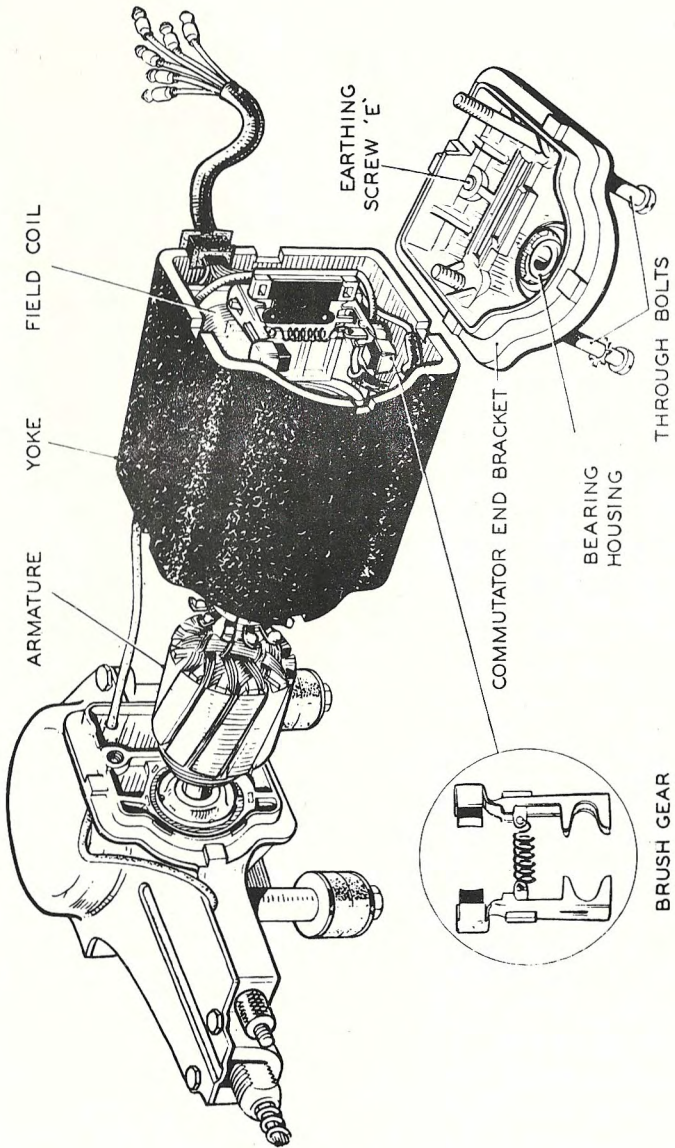

ELECTRIC WIRING DIAGRAM LUCAS MODEL SF4 TYPE NEGATIVE EARTH

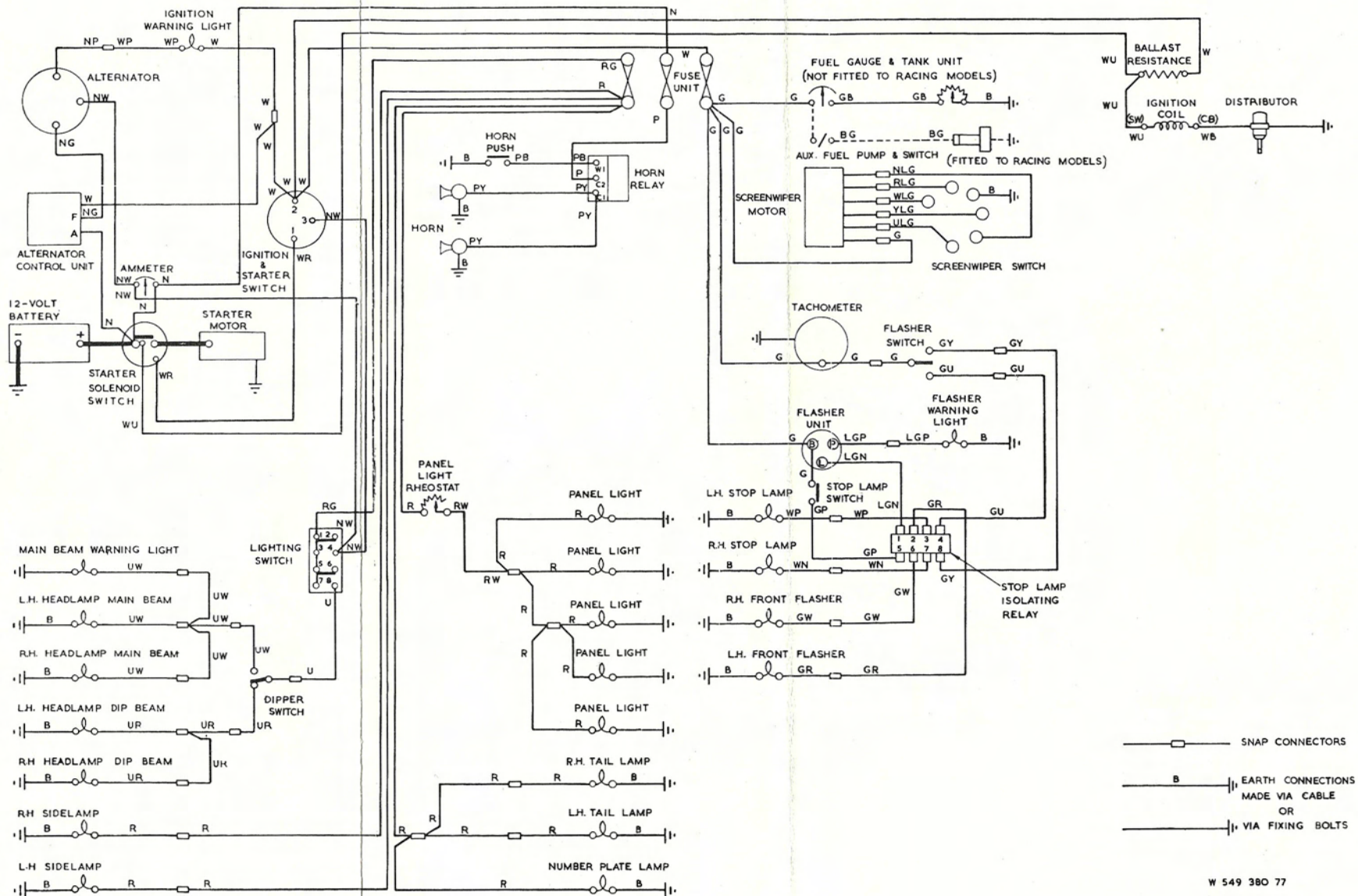

LUCAS MODEL SF4 TYPE

FUSE BOX

The fuse box contains four 45 amp. fuses, one of which is spare. Access to these fuses is obtained by removing the push-on cover.

The units which are protected by the fuses can readily be identified by referring to the wiring diagram.

A blown fuse is indicated by the failure of all the units protected by it, and is confirmed by examination of the fuse, which can easily be withdrawn from the spring clips in which it fits. If it has blown, the broken ends of the wire will be visible inside the glass tube. Before replacing a blown fuse inspect the wiring of the units that have failed for evidence of a short circuit, or other fault which may have caused the fuse to blow and remedy the cause of the trouble.

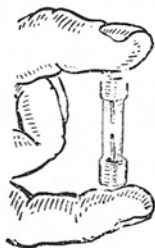

It is important to use only the correct replacement fuse. The fusing value is marked on a coloured slip inside the glass tube of the fuse.

If the new fuse blows immediately and the cause of the trouble cannot be found, have the equipment examined at a Service Depot or Agent.

THE STARTER

When starting:—

1. See that the controls are properly set.
2. Operate the starter key firmly and release it as soon as the engine fires.
3. Do not operate the starter when the engine is running. If the engine will not fire at once, allow it to come to rest before operating the starter again.
4. Do not run the battery down by keeping the starter on when the engine will not start.

HEADLAMPS—AMERICA

Lucas sealed beam headlights are fitted to all cars for the American continent. This is a sealed unit and in the event of a fault occurring it will be necessary to change the light unit.

HEADLAMPS—EUROPE

Each headlamp incorporates a Lucas Light Unit which consists essentially of a reflector and "block-pattern" lens assembly provided with a mounting flange by means of which it is secured in the body housing. The bulb is located accurately in the reflector and is secured by a bayonet-fixed backshell, which also provides the contact to the bulb. The design of the bulb and of its holder is such that the bulb is correctly positioned in relation to the reflector and no focusing is required when a replacement bulb is fitted.

Identical double-filament bulbs are fitted in each lamp. In the dipped position, both headlamp beams are deflected downwards and to the left, right, or vertically, depending on local anti-dazzle legislation.

TO REMOVE THE LIGHT UNIT FOR BULB RENEWAL—EUROPE

Remove the front rim by unscrewing the rim securing screw and lifting off the rim. Next remove the rubber dust excluder, when three spring loaded adjustment screws will be visible. Press the Light Unit in

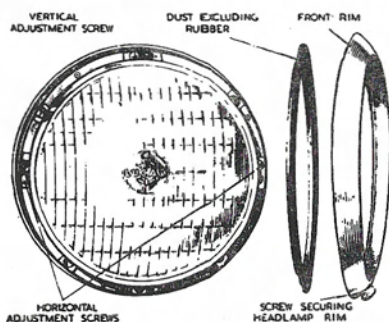

against the tension of the adjustment screw springs and turn it in an anti-clockwise direction until the heads of the screws can be disengaged through the slotted holes in the Light Unit rim. Do not disturb the screws when removing the Light Unit or the Lamp setting will be altered.

Twist the back shell in an anti-clockwise direction and pull it off. The bulb can now be removed from the rear of the reflector.

Place the replacement bulb in the holder, taking care to locate it correctly. Engage the projections on the inside of the back shell with the slots in the holder, press on and secure by twisting it to the right.

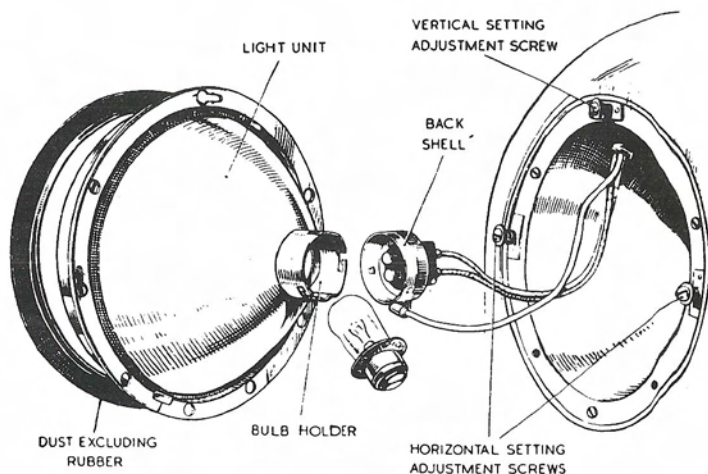

Position the Light Unit so that the heads of the adjusting screws protrude through the slotted holes in the flange, press the unit in and turn in a clockwise direction. Replace the rubber ring so that the thicker inner edge rests in the recess around the Light Unit rim.

Refit the front rim, locating the top of the rim first and secure by means of the fixing screw.

HEADLAMP SETTING

The lamps should be set so that the main driving beams are parallel with the road surface and with each other. If adjustment is necessary, remove the front rim and dust excluding rubber as described above and trim each lamp to the correct position by means of the three spring loaded adjustment screws.

The setting of the lamps can be carried out by placing the car in front of a blank wall at the greatest possible distance, taking care of course that the surface on which the car is standing is not sloping relative to the wall.

Cars fitted with sealed beam headlights are adjusted in this manner with two set screws which are exposed when the lamp rim is removed.

INFORMATION CONCERNING MAINTENANCE

289 AND 427 V.8. HIGH PERFORMANCE ENGINES 289 HIGH PERFORMANCE ENGINE SPECIFICATIONS

GENERAL

Type	8-cylinder 90° Vee, Overhead Valve
Displacement	289 Cubic Inches
Bore and Stroke	4-00" x 2-87"
Compression Ratio	10-5:1
Brake Horsepower	271 @ 6000 r.p.m.
Maximum Torque	312 lbs./ft. @ 3400 r.p.m.
Valve Lifters	Solid
Carburettor	One 4-venturi
Fuel	Super Premium
Cylinder Block Material	Precision Cast Iron
Cylinder Head Material	Precision Cast Iron
Oil Filter	Rotunda 6000 Mile Type, Part Number CIAZ-6731-A (R1-A)

CRANKSHAFT

Material	Precision-Molded Alloy Cast Iron
Main Bearings (5)	Steel-Back Copper- Lead Alloy Replaceable Inserts
Main Bearing Journal Diameter	2-2482"-2-2490"
Thrust Bearing	No. 3
Crankpin Journal Diameter	2-1228"-2-1236"

CAMSHAFT

Material	Precision-Molded Special Alloy Iron
Bearings (5)	Steel-Back Babbitt Inserts
Camshaft Gear Material	Cast Iron

VALVE SYSTEM

Operating Tappet Clearance	0-018 (hot). Hot setting to be made after a minimum of 30 minutes @ 1200 r.p.m. (no load)
Intake Valve Opens	0-008 @ 46° BTDC
Intake Valve Closes	0-010 @ 84° ABDC
Duration	324°
Exhaust Valve Opens	0-008 @ 94° BBDC
Exhaust Valve Closes	0-010 @ 36° ATDC
Duration	324°
Valve Opening	96°

INTAKE VALVES

Material	S.A.E. 1047 Alum- inized Steel
Overall Length	4-863"
Overall Head Diameter	1-662"-1-667"
Angle of Seat	44°
Lift	0-477"
Spring Pressure and Length	83-5-92-5 lbs. @ 1-77" (valve closed) 234-5-259-5 lbs. @ 1-32" (valve open)

EXHAUST VALVES

Material	21-4N Forged Steel Aluminized
Overall Length	4-863"
Overall Head Diameter	1-442"-1-457"
Angle of Seat and Face	44°
Lift	0-477"
Spring Pressure and Length	83-5-92-5 lbs. @ 1-77" (valve closed) 234-5-259-5 lbs. @ 1-32" (valve open)

PISTONS

Material	Extruded Alumin- ium Cam Ground
Weight	21-09 oz.

PISTON RINGS

No. 1 Compression	Cast Iron Alloy, Straight Face, Chrome Plated
No. 2 Compression	Cast Iron Alloy, Straight Face, Sca- rapper Groove, Phos- phate Coated
No. 3 Oil Control	Multi-Piece, Two Rails and One Spa- cer Expander, Steel Rails, Chrome Pla- ted, Oxide Coated Expander—Blued Steel
Width—No. 1	0-0774"-0-0781"
No. 2	0-0930"-0-0940"
Gap—Nos. 1 and 2	0-010"-0-020"
No. 3	0-015"-0-055"

PISTON PINS

Type	Press-Fit in Rod
Material	S.A.E. 5015 Alloy Steel, Heat Treated
Length	3-010"-3-040"
Diameter	0-9119"-0-9124"

CONNECTING RODS

Material	S.A.E. 1041 Forged Steel, with separate- ly forged Caps
Weight	20-776-21-059
Length	5-1535-5-1565

CONNECTING ROD BEARINGS

Material	Steel-Back Copper- Lead Alloy Inserts
Overall Length	0-716"-0-726"
Clearance Limits	0-0009"-0-0029"

GENERAL

Firing Order	1-5-4-2-6-3-7-8
Valve Clearance	0-022 cold-0-018 hot
Cam Lobe Life (normal)	0-298
Cam Lobe Wear Limit	0-005
Valve Lift (theor- etical zero lash)	0-477

Compression Pressure (sea level)	130-170 p.s.i.
Idle Manifold Vacuum	15" HG
High performance V-8 (4-V)	280 @ 6000 Brake horsepower
High performance V-8 (4-V)	340 @ 3400 Torque

IGNITION SYSTEM

Initial Ignition Timing (new points)	12° BTDC
Final Ignition Timing (tune-up)	12° BTDC
Distributor Number	C5AZ-12127-EEZ
	Advance
Centrifugal Advance (set test stand to 0° at 2500 r.p.m. and 0' HG)	r.p.m. Degrees
	650 2½-3½
	750 4-5½
	1000 6½-7½
	1600 7½-8½
	2000 8½-9½
Maximum Advance	14°

BREAKER POINTS

Arm Spring Tension (std. ignition)	27-30 oz.
Contact Spacing	0-019-0-021
Dwell Angle at Idle Speed, std. ignition combined	30-33°
Standard Spark Plugs	Part No. COAZ-12405-A (BF-32)
Spark Plug Size	18MM
Standard Plug Gap	0-028-0-032
Width	
Spark Plug Torque	15-20 lbs./ft.

FUEL SYSTEM

Carburettor Number	C40F-9510-AL	C50F-9510-L
Main Metering Jet Identification	52F-P	50F-P
Power Valve Colour (normal) (altitude)	68F-S	66F-S
Float Setting (dry)	Plain Green	
(wet)	18" P	28" S
	7" P	28" S
Initial Idle Mixture Setting	1-1½ turns open	
Accelerator Pump Setting	Inboard No. 3	
Choke Spring Housing, Initial Setting	Manual	
Maximum (hot) Idle Adjustment	750-775 r.p.m.	
Fuel Pump Static Pressure	4-6 p.s.i. @ 500 r.p.m.	

TORQUE LIMITS

Intake Manifold	20-22 ft.-lbs.
Exhaust Manifold	13-18 ft.-lbs.
Oil Pan Drain Plug	15-20 ft.-lbs.
Oil Filter	With oil on gasket surface, hand tighten until gasket contacts adapter face; then tighten ½ turn more
Connecting Rod Retaining Nut	40-45

427 HIGH PERFORMANCE ENGINE SPECIFICATIONS

GENERAL

Type	8-cylinder 90° Vee, Overhead Valve
Displacement	427 Cubic Inches
Bore and Stroke	4-2328" x 3.784"
Compression Ratio	11-1:1
Brake Horsepower	4V-410 @ 5600 r.p.m. 8V-425 @ 6000 r.p.m.
Valve Lifters	Solid
Carburettor	Two 4-venturi
Fuel	Super Premium
Exhaust	Dual
Cylinder Block	Precision-Cast Iron
Material	
Cylinder Head	Precision-Cast Iron
Material	
Oil Filter	Rotunda 6000 Mile Type-Part Number CIAZ-6731-A (R1-A)
High Performance V-8 (8-V)	425 @ 6000 Brake Horsepower
High Performance V-8 (8-V)	480 @ 3700 Torque

CRANKSHAFT

Material	Precision-Molded Alloy Cast Iron
Main Bearings (5)	Steel-Back Copper-Lead Alloy Replaceable Inserts
Main Bearing Journal Diameter	2-7484"-2-7492"
Thrust Bearing Crankpin Journal Diameter	No. 3 2-4380"-2-4388"

CAMSHAFT

Material	Precision-Molded Special Alloy Iron
Bearings (5)	Steel-Back Babbitt Inserts
Camshaft Gear Material	Molded Nylon on Aluminum Die Cast

VALVE SYSTEM

Operating Tappet Clearance	0-025 (hot)
Intake Valve Opens	0-006 @ 48° BTDC
Intake Valve Closes	0-008 @ 96° ABDC
Duration	324°
Exhaust Valve Opens	0-006 @ 96° BBDC
Exhaust Valve Closes	0-008 @ 48° ATDC
Duration	324°
Valve Opening	96°

INTAKE VALVES

Material	Special Alloy Valve Steel with Aluminium Coated Head
Overall Length	5-446"
Overall Head Diameter	2-022"-2-037"
Angle of Seat and Face	29°
Life	0-500" at valve
Spring Pressure and Length	80-90 lbs. @ 1-82" (valve closed) 255-280 lbs. @ 1-32" (valve open)

EXHAUST VALVES

Material	21-4N Forged Steel with Chrome Plated Stem and Silichrome tip
Overall Length	5-246"
Overall Head Diameter	1-723"-1-733"
Angle of Seat and Face	44°
Lift	0-298" at Valve
Spring Pressure and	80-90 lbs. @ 1-82" (valve closed) 255-280 lbs. @ 1-32" (valve open)

PISTONS

Material	Extruded Aluminium Cam, Ground
Weight	23-31 oz.

PISTON RINGS

No. 1 Compression	Cast Iron Alloy Chrome Plated
No. 2 Compression	Cast Iron Alloy Chrome Plated
No. 3 Oil Control	Multi Piece—Two Chrome Plated Steel Rails and One Blued Steel Expander
Width—No. 1	0-0774"-0-0781"
No. 2	0-0930"-0-0940"
Gap—Nos. 1 and 2	0-010"-0-020"
No. 3	0-015"-0-055"

PISTON PINS

Type	Full Floating Tubular
Material	S.A.E. 5015 Alloy Steel Heat Treated
Length	2-202"-3-212"
Diameter	0-9750"-0-9753"
Bushing	Bronze

CONNECTING RODS

Material	Forged Steel with separately Forged Caps
Weight	26-85-27-30 oz.
Length	6-486"-6-490"
	Centre to Centre

CONNECTING ROD BEARINGS

Material	Steel-Back Copper-Lead Alloy Inserts
Overall Length	0-736"-0-746"
Clearance Limits	0-0013"-0-0032"

GENERAL

Firing Order	1-5-4-2-6-3-7-8
Valve Clearance	0-028 cold-0-025 hot
Cam Lobe Lift (normal)	0-298
Cam Lobe Wear Limit	0-005
Valve Lift (theoretical zero lash)	0-500
Compression pressure (sea level)	160-200 p.s.i.

IGNITION SYSTEM

Initial Ignition	8° BTDC
Timing (New Points)	
Final Ignition	8° BTDC
Timing (tune-up)	

Distributor Number	C5AZ-12127-EEZ		
		Advance	
	r.p.m.	degrees	
Centrifugal Advance	650	2½-4	
(set test stand to 0°	750	4 -5½	
at 2500 r.p.m. and	1000	7½-8½	
0° HG)	1600	9½-11	
	2000	11½-13	
Maximum Advance	16°		
Limit			
Vacuum Advance	Advance	Vacuum	
(set test stand to	r.p.m.	degrees	In. HG
9° at 1000 r.p.m.	1000	2-5	8
and 0° HG)	1000	4-7	10
	1000	5½-8½	14
Maximum Advance	8½°		

BREAKER POINTS

Arm Spring Tension			
std. ignition	27-30 oz.		
trans. ignition	22-24 oz.		
Contact Spacing	0-019-0-021		
Dwell Angle at Idle			
Speed-std. ignition			
combined	30-33°		
trans. ignition	22-24°		
Standard Spark			
Plugs Part Number	COAZ-12405-A		
			(BF-32)
Spark Plug Size	18 MM		
Standard Plug Gap	0-028-0-032		
Width			
Spark Plug Torque	15-20 lbs./ft.		

FUEL SYSTEM

Carburettor	C4AF-9510-BJ primary
Part Number	C4AF-9510-BK second.or
	C4AF-9510-CU primary
	C4AF-9510-CV second.

Main Metering	C4AF-9510-BJ-46F-58F
Jet Identification	C4AF-9510-CU-71 F-74F
	C4AF-9510-BK-46F-48F
	C4AF-9510-CV-71 F-74F

Float Setting (dry)	Top of float to be parallel with top of inverted fuel bowl.
(wet)	Fuel level at lower edge of sight plug.
	1-1½ turns open

Initial Idle Mixture Setting	
Accelerator Pump Setting	Summer—No. 1
Accelerator Pump Clearance	Winter—No. 2
Thermostatic Spring Identification	0-015
Choke Spring Housing Initial Setting	58LI
Fast (cold) Idle Adjustment	At Index Mark
Maximum (hot) Idle Adjustment	1500 r.p.m.
Fuel Pump Static Pressure	700-800 r.p.m.
	4½-6½ p.s.i. @
	500 r.p.m.

TORQUE LIMITS

Intake Manifold	32-35 ft.-lbs.
Exhaust Manifold	12-18 ft.-lbs.
Oil Pan Drain Plug	15-20 ft.-lbs.
Oil Filter	With oil on gasket surface, hand tight-en until gasket contacts adapter face; then tighten ½ turn more.
Connecting Rod Retaining Nut	53-58

DASHBOARD INSTRUMENTATION

- | | | |
|-----------------------|-----------------------|-------------------------|
| 1. High Beam. | 8. Fuel Guage | 15. Horn. |
| 2. Indicator Light. | 9. Panel Lights. | 16. Screen Washer. |
| 3. Speedometer. | 10. Wiper. | 17. Indicator Lever. |
| 4. Oil pressure Guage | 11. Glove Box. | 18. Ignition Key. |
| 5. Water Temp. Guage | 12. Cigar Lighter. | 19. Revolution Counter. |
| 6. Oil Temp. Guage | 13. Heater, two-speed | 20. Air Control. |
| 7. Ammeter | 14. Headlamps. | 21. Ignition Light. |

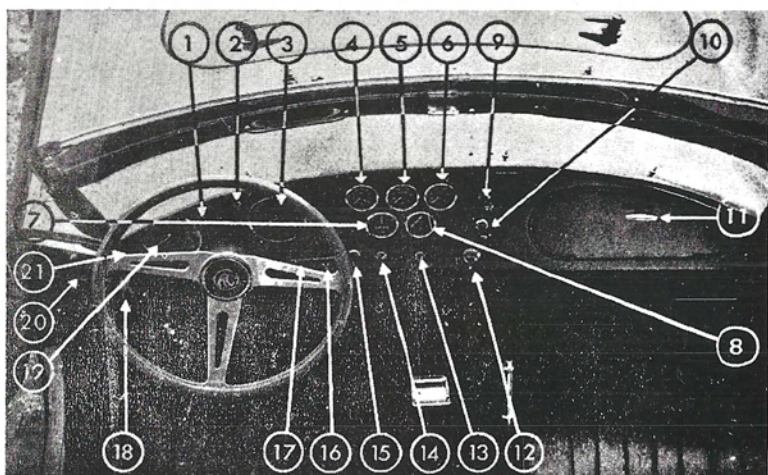

ERECTING FOLDING SOFT TOP

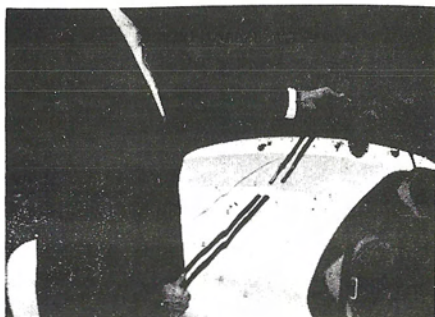

1. Remove soft top bars from rear boot.

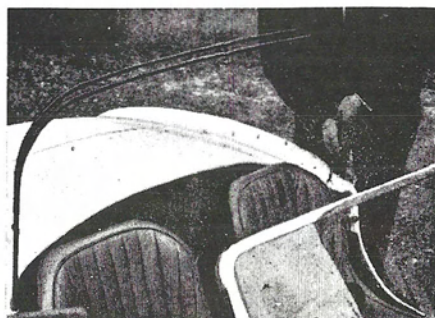

2. The two sections must be joined together and inserted in the sockets provided at rear of cockpit.

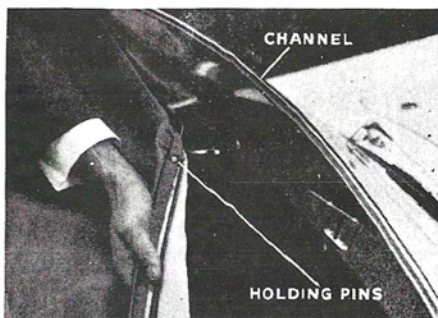

3. Remove the soft top from the pocket provided at rear of seats, holding the metal front section near the centre pins.

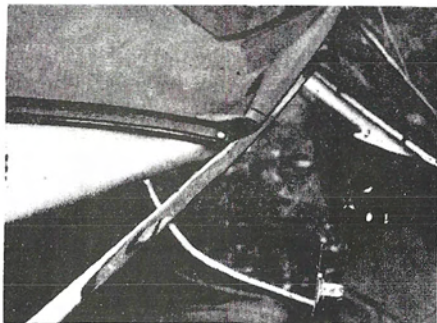

4. Insert centre holding pins in the slot provided in windscreen centre. Press the holding pins into the slot one at a time and pull sideways to engage the head of the pin under the channel.

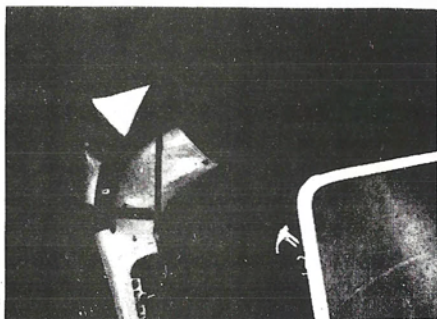

5. Push down studs at rear of the soft top with exception of the last three on either side.

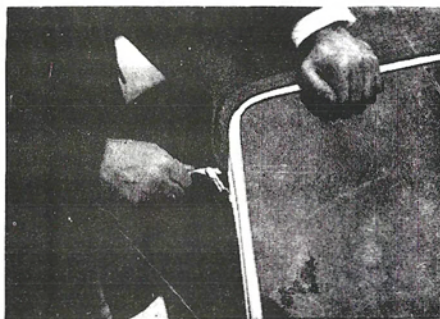

6. Push down holding clips at side of windscreen.

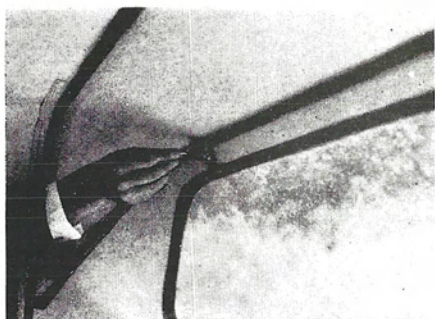

7. Push rear folding soft top hoop backwards to tension soft top and do up internal securing tabs.



8. Push down remaining six studs on rear deck.

To remove the soft top reverse this procedure.

The thick perspex side screens are secured by inserting the bottom bars into door sockets.

WHEN FOLDING SOFT TOP ADOPT THE FOLLOWING
PROCEDURE



1

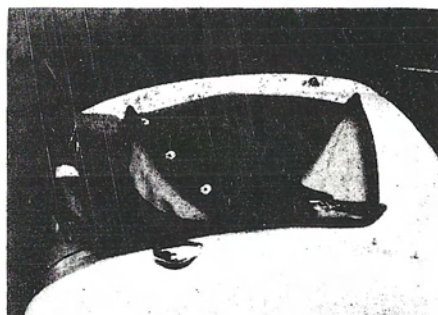

2

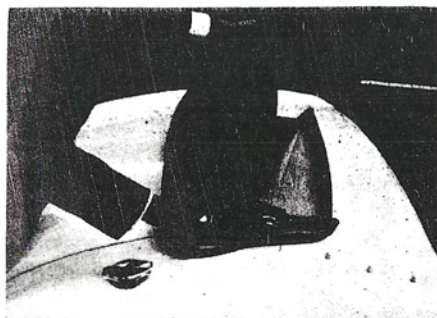

3

CHASSIS INDEX

		<i>Page</i>
A.	Armature	39
	Ammeter readings... ..	36
B.	Brake instructions... ..	22
	Brake cylinder maintenance	22
	Brake pad replacement	23
	Brake system bleeding	28
	Battery maintenance	35
C.	Cooling system	2
	Clutch system bleeding	23
	Coil... ..	34
	Contact breaker	34
	Commutator	39
	Cut out adjustments	45
	Coachwork... ..	60
D.	Dynamo diagram	41
	Dashboard bulbs	54
	Dashboard instrumentation	55
E.	Electrical maintenance	34
	Electric engine cooling fan	34
	Electrical setting data	44
	Electric wiring diagram	52
	Electric horns	53
	Erecting hood or soft top	56
F.	Folding soft top	59
	Field coils	40
	Front brake pads replacement	25
	Front brake illustration	24
	Foreword	1
	Front hub removal	12
	Front bearings removal	13
	Front hub and caliper drawing B	14
	Front hub part numbers	15
	Front brake caliper removal	17
	Front suspension vertical link removal... ..	17
	Front hub and suspension drawing A	13

INDEX

PAGE	
1	Foreword.
2	Useful information/Cooling system.
3	Propeller shaft and half shafts.
4	Salisbury differential mounting part numbers.
5	Salisbury differential "Powr Lok" unit.
6	Salisbury differential Friction Clutch loading.
7	" " " " "
8	Salisbury differential drawing.
9	Salisbury differential part numbers.
„	Salisbury tool list.
10	Removal of rear hub.
„	To dismantle rear hub and upright.
11	Rear hub and caliper drawing.
12	Rear hub part numbers.
13	To remove rear wheel bearing.
14	Rear suspension.
15	Rear suspension illustration.
16	Rear suspension.
17	Removal of front hub.
„	To remove front caliper.
„	To remove front vertical link.
18	Front hub and caliper drawings.
19	Front hub part numbers.
20	To remove front wheel bearings.
„	Front suspension upper ball joint.
21	Front suspension lower ball joint.
22	Front suspension ball joint photographs.
23	Front upper and lower wishbones.
„	Front suspension photograph.
24	Steering disassembly.
25	Refitting steering rack.
„	Steering ball joints.
26	Steering drawing.
27	Steering part numbers.
28	Brake instructions and running adjustments.
29	Brake lining pad replacement.
„	Clutch bleeding.
30	Front brake photograph.
31	Replacing brake pads.

PAGE	
32	Rear brake photograph.
33	Handbrake adjustment.
34	Bleeding the brake system.
35	Front and rear shock absorbers.
36	Shock absorber part numbers.
37	Petrol tank removal.
„	Recommended oils.
38	Salisbury axle technical data and oils.
39	Servicing and greasing information.
40	Electrical general maintenance.
„	Electric engine cooling fans.
41	Lucas batteries.
42	Ammeter readings.
43	Lucas electric horns
44	Ignition warning light.
„	Dashboard bulbs.
45	Headlamp bulb information.
„	Side and tail lamp bulbs.
46	Lucas two-speed wipers.
47	Lucas wiper illustration.
48	Electric wiring diagram.
49	Fuse box.
50	The starter.
„	Headlamps Europe and America.
51	Headlamp removal and setting.
52	289 Engine maintenance.
53	289 Engine maintenance.
54	427 Engine maintenance.
55	427 Engine maintenance.
56	Dashboard instrumentation.
57	Erecting folding soft top.
58	Erecting folding soft top.
59	Erecting folding soft top.
60	Packing folding soft top.
61	Coachwork maintenance.
„	Spares guidance.